



LacasseOfficeFurniture.com 201-254-0145

Groupe Lacasse Half Price Sale On Now

Take Half Off the List Prices in this PDF

Call 201-254-0145 Now

Free Layout & Design Service

Nex Series



TABLE OF CONTENTS

SPECIFICATIONS 2

NEX COLLECTION 2

HEIGHT MANAGEMENT AND STACKING COMPATIBILITY 3

DESKS AND SURFACES 3-4

RETURNS 4

RETURN-SURFACES 5

WORK SURFACES WITH STRUT(S) 5-6

ELECTRIC HEIGHT ADJUSTABLE DESKS 6-7

ELECTRIC HEIGHT ADJUSTABLE DESKS WITH RETURN 7-9

CAFÉ HEIGHT TABLES, MEETING TABLES AND COMPLEMENTARY FURNITURE 10

CUSHIONS 10

STORAGE FURNITURE 11-12

MEDIA PANELS 12-13

MODULAR PRIVACY SCREENS 13

ACCESSORIES 14

APPLICATION OF TWO-TONE AND HIGH-GLOSS FINISHES 14-15

STANDARD SPECIALS 15

SPECIFICATIONS OF OPTIONS AND FINISHES 15

NEX PRICE LIST 16

DESKS 16

WORK SURFACES 16

DESKS WITH MEETING SPACE 17

WORK SURFACES WITH MEETING SPACE 18

COLLABORATIVE SURFACES 19

WORK SURFACES WITH STRUT(S) 20

RETURN-SURFACES 21

RETURNS 21

ELECTRIC HEIGHT ADJUSTABLE DESKS AND RETURNS 22

CAFÉ HEIGHT TABLES 25

MEETING TABLES 26

COMPLEMENTARY FURNITURE 27

STORAGE MODULES – 21" H. 28

STORAGE MODULES – 27" H. 30

STORAGE FURNITURE 32

BOOKCASE HUTCHES 34

MEDIA PANELS 36

WALL-MOUNTED HUTCHES 36

PEDESTALS 37

ACCESSORIES 37

SUGGESTIONS 39



Lacasse products have achieved GREENGUARD GOLD Certification.

GREENGUARD Certified products are certified to GREENGUARD standards for low chemical emissions into indoor air during product usage. For more information, visit ul.com/gg.

SPECIFICATIONS

NEX COLLECTION

NEX is a stylish collection of furniture. It offers superior value and incomparable flexibility in its layout possibilities.

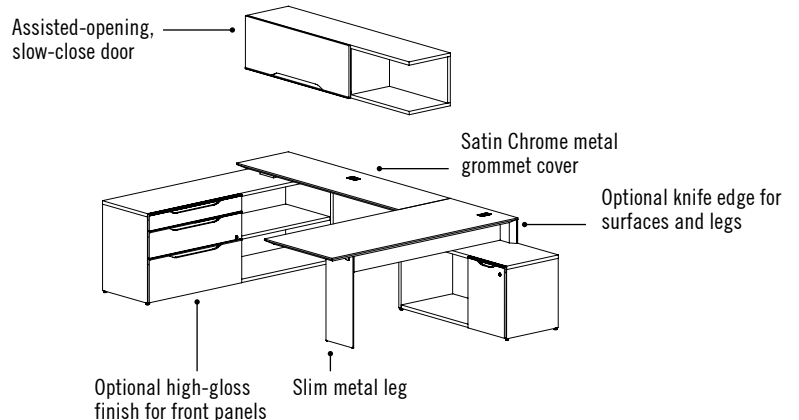
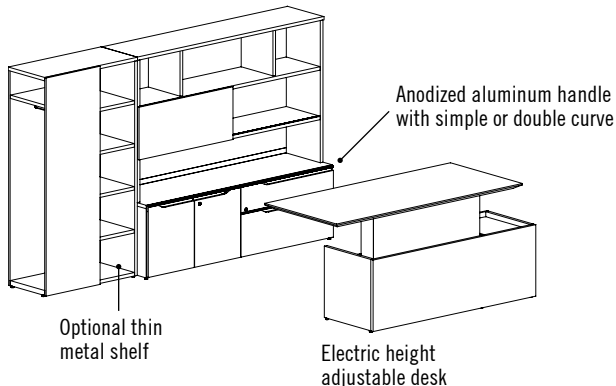

HEIGHT MANAGEMENT AND STACKING COMPATIBILITY

The modular nature of the NEX collection's various components enables units of different heights to be aligned so as to ensure visual consistency between work stations. Here is an overview of the principal heights (measurements in Imperial units are nominal):

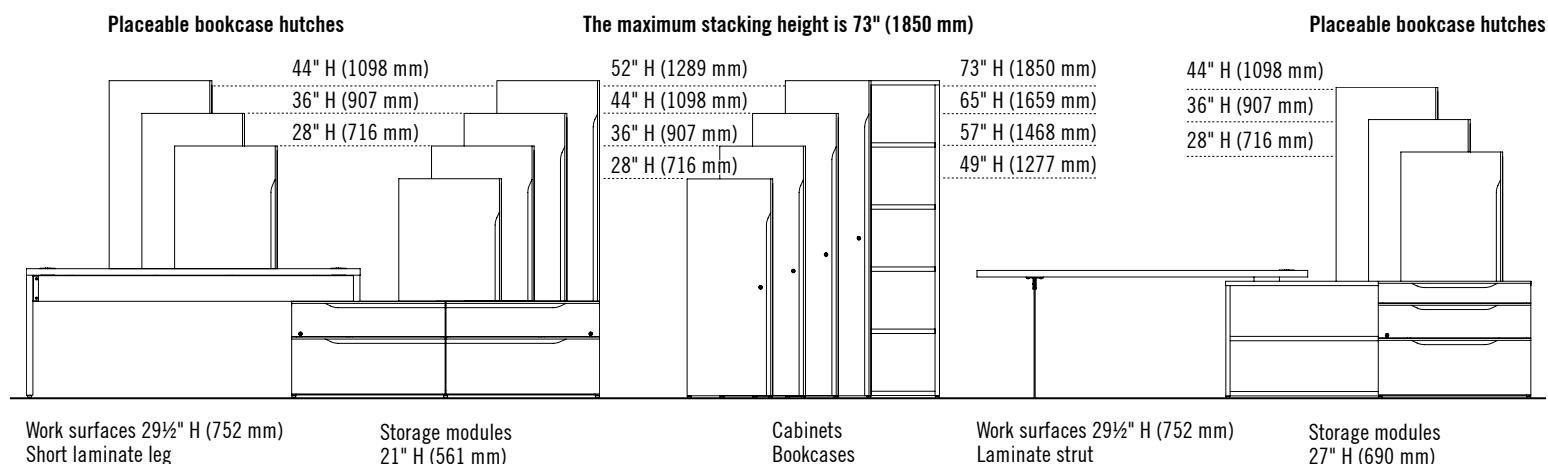

The 21" H (561 mm) storage module does not create a gap between a shelf or a media panel and a cabinet/bookcase placed next to it.

2½" (64 mm) gap between a shelf or a media panel and a cabinet/bookcase placed next to it.

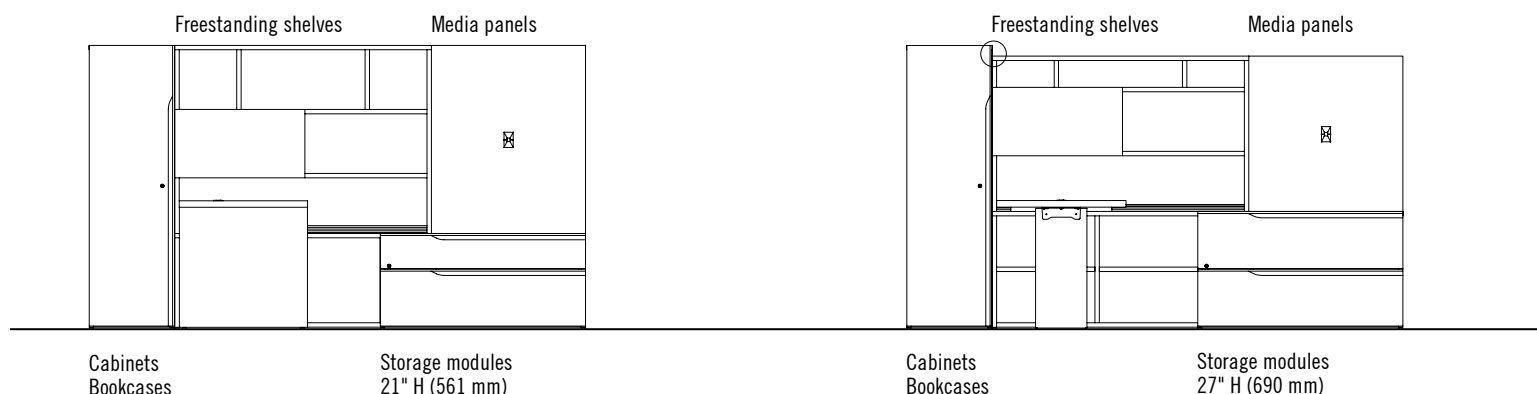

DESKS AND SURFACES

General characteristics

All desks, work surfaces and returns from the NEX collection are available with a choice of top panel 1" (25 mm) thick with smooth edgebanding or 1½" (38 mm) thick with smooth or knife edge.

Top panels have at least 1 grommet with a metal cover with a satin chrome finish (excluding the return-surfaces and the height adjustable desks). The opening of the grommet can accommodate an electrical module unless indicated otherwise (surfaces with struts).

Desks and returns 20" (500 mm) in depth are not compatible with suspended cabinet NNN_ _-161820F.

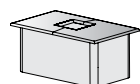

Grommet with metal cover

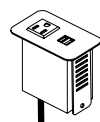

Electric module
LGC-PCQ1USB1P

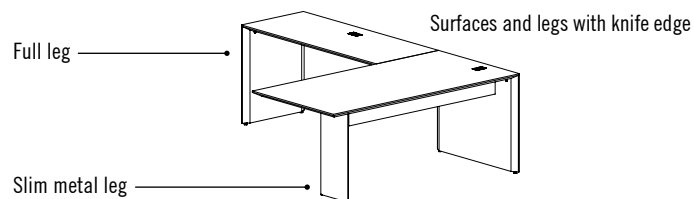

Short or long laminate legs are always 1½" (38 mm) thick and some desk or surface models have a slim, mechanically height adjustable metal leg.

- Slim metal leg**
- Steel with brushed chrome satin finish.
 - Translucent plastic floor bumpers.
 - 1" (25 mm) height adjustment.

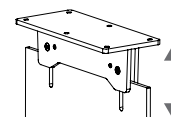

NEX COLLECTION (cont'd)

Desks

Desks with recessed short backs

- Built with recessed back, 6" (150 mm) in height.

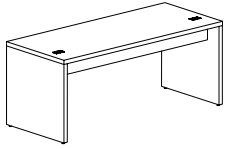

2 long legs – laminate

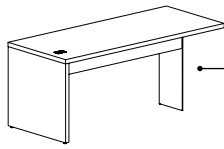

1 long leg – laminate
1 long leg – metal

The slim metal leg is always 13" (340 mm) recessed.

Desks with recessed full-height modesty panels

- Compatible with pedestals NNN_--161820F or NNN_--MP161820F.
- Modesty panel can have a laminate or High-Gloss Black or High-Gloss White finish.

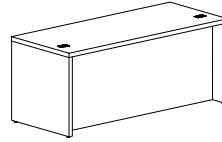

2 long legs – laminate

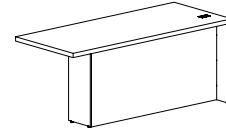

1 long leg – laminate

Desks with short backs are compatible with 21" H (561 mm) storage modules.

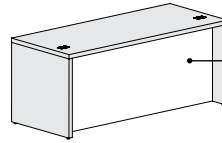
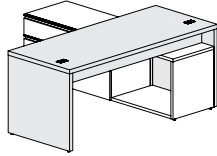
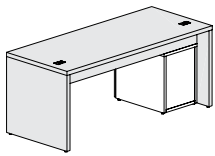

Modesty panel

Work surfaces

Surfaces with short backs may be placed on top of 1 or 2 21" H (561 mm) storage modules from the NEX collection. They are mounted using double-sided tape.

Surfaces with short backs

- Built with recessed back, 6" (150 mm) in height.

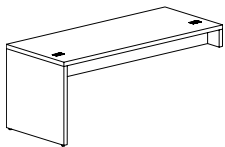

1 long leg – laminate
1 short leg – laminate

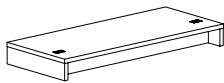

2 short legs – laminate

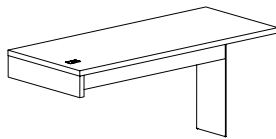

1 short leg – laminate
1 long leg – metal

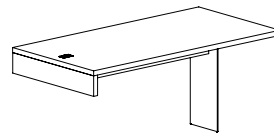

1 short leg – laminate
1 long leg – metal

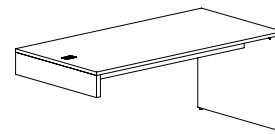

1 short leg – laminate
1 long leg – laminate

There are multiple possibilities for layout and positioning. Here are a few examples:

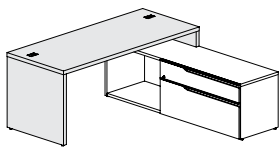

1 storage module positioned perpendicularly

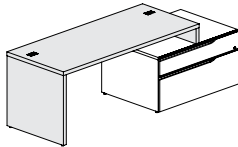

1 storage module placed underneath

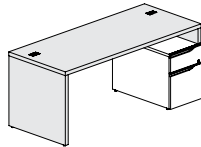

1 storage module positioned toward the outside

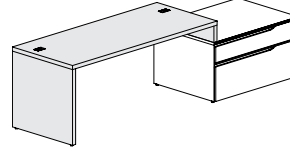

1 storage module positioned during installation

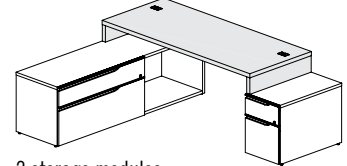

2 storage modules positioned perpendicularly

RETURNS

General characteristics

Returns are always connected to another surface. They are available with a short or long laminate leg and a short back, 6" (150 mm) in height with a 3" (75 mm) recess. Returns with a short leg must be installed on a 21" H (561 mm) storage module and are attached with double-sided tape. Multiple connections are possible.

Returns – short leg

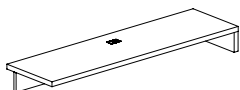

Returns – long leg

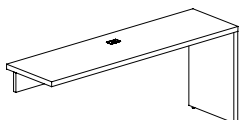

Return with a short leg

Return with a long leg

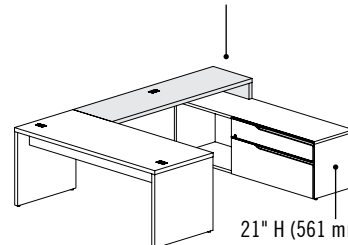

21" H (561 mm) storage module

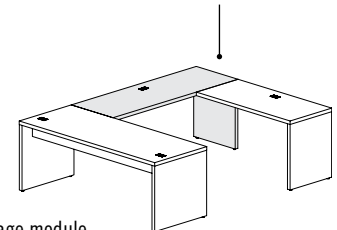

RETURN-SURFACES

Return-surfaces can be used to create meeting surfaces that are perpendicular to a given surface. They are always connected to another surface with mounting brackets (included). Modular modesty panels with steel ties have been designed for use with them. Refer to page 15.

Return-surfaces

Possible configurations:

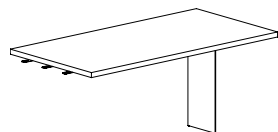

Flush plates
1 long leg - metal

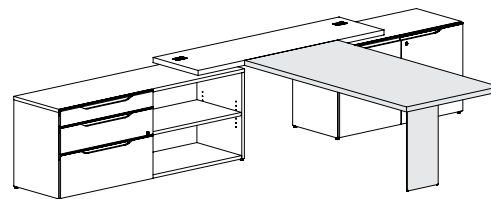
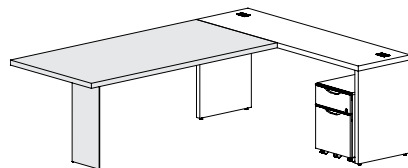

Unauthorized configurations:

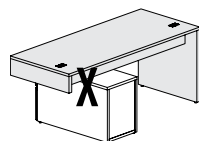

The short leg must always be placed on top of the storage module.

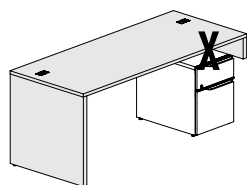

The storage module depth must be equal or greater than that of the surface.

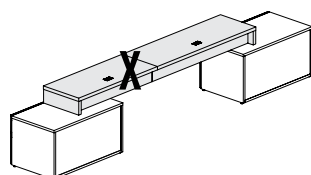

The junction between a surface and a return must lie along a low storage module.

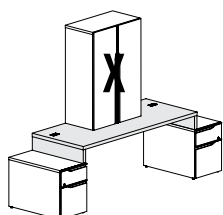

Stackables must be placed above solid structures such as desk legs or storage modules.

Non-recommended configurations:

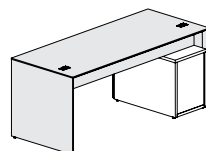

It is recommended that a storage module be positioned beneath a surface and with a recess of approximately 2" (51 mm) when the surface and its legs have knife edgebanding.

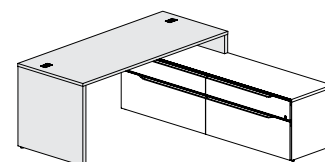

Stacking certain pieces of furniture may render their drawers partially or completely inaccessible beneath the surface. It is preferable to choose a different storage configuration.

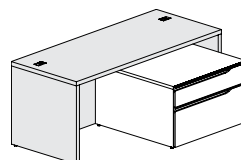

A careful selection of furniture depths helps avoid a situation where the storage module exceeds the surface depth.

WORK SURFACES WITH STRUT(S)

General characteristics

Elevated surfaces have 1" or 1½" (25 or 38 mm) thick, factory-installed laminate struts that come in a matching finish. These surfaces must be installed on 27" H (690 mm) storage modules with double-sided tape.

Elevated surfaces can accommodate modular privacy screens and modesty panels specially designed for use with them. Refer to the price list. Grommets for raised surfaces cannot accommodate electric module LGC-PCQ1USB1P.

Rectangular surfaces

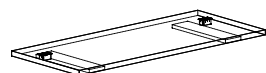

2 struts – laminate

Rectangular tables

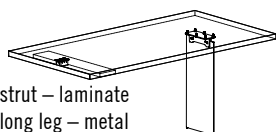

1 strut – laminate
1 long leg – metal

Returns

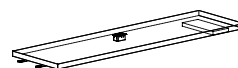

1 strut – laminate
Flush plates

Examples of work stations:

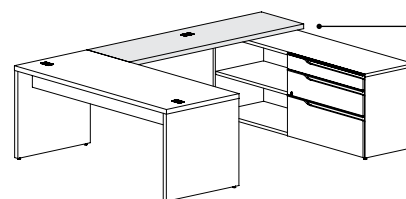
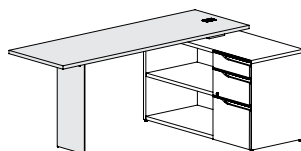
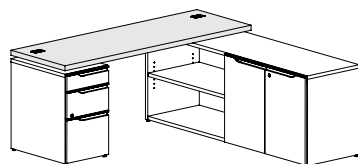

2½" (68 mm) gap between the top of the surface and the top of the storage module

SPECIFICATIONS

WORK SURFACES WITH STRUT(S) (cont'd)

Positioning of struts

A strut may be positioned anywhere along one or two 27" H (690 mm) storage module(s). It is important to make sure that all of its surface is in contact with the storage module(s).

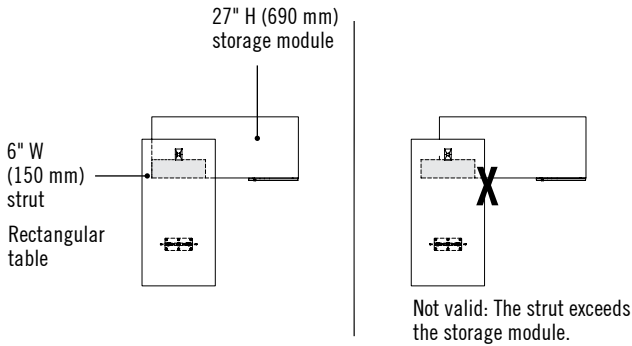

Non-recommended configurations:

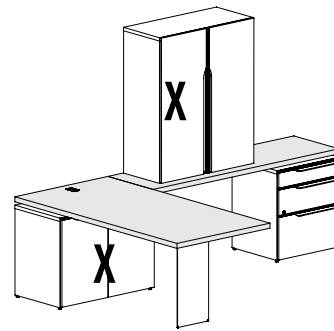

- Shelves must be placed on top of solid structures.
- No raised surface above a storage module with a door.

ELECTRIC HEIGHT ADJUSTABLE DESKS

NEX electric height adjustable desks are very easy to use. They favor an active mode of work (sitting/standing) and can be adapted to users of different heights.

General characteristics

- 1- The laminate back is removable and enables access to the power cable.
- 2- The front panel of the integrated module may have a laminate or high-gloss black or high-gloss white finish.
- 3- The open compartment above the integrated module can accommodate small personal items. The base of the open compartment is covered with textured, ½" (13 mm) thick grey felt. An optional cutout for a round wireless charger, LGC-CHARGE, for the open compartment is available as a Standard Special (see p. 15).
- 4- Optional grommets for the surface available as a Standard Special (see p. 15).
- 5- The metal back is available in a choice of Black or White accent color.
- 6- Cantilevered meeting space with a 17" (425 mm) span, except for the 66" L (1650 mm) surface, which has an 11" (275 mm) meeting space.
- 7- A 6" (152 mm) vertical clearance beneath the integrated module makes it possible to accommodate a floor monument.

Electric height adjustment

- Control keypad is installed beneath the work surface.
- Operating speed: 1¼" (32 mm) height adjustment per second.
- Sound level: 48 dB.
- Lift capacity of 2 columns: 264 lbs (120 kg).
- Recommended functional load capacity: 100 lbs (45 kg).
- Failure to respect the loads can cause the table/desk to malfunction.
- 120" (3048 mm) cable with plug for wall outlet. 6' (1829 mm) of connector cable available outside the desk.
- Meet CSA and UL standards.



Digital control keypad with memory

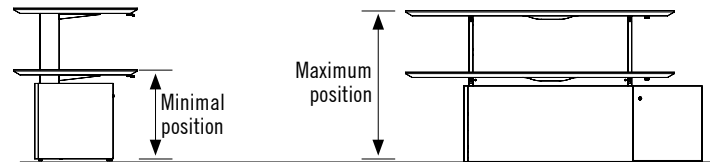
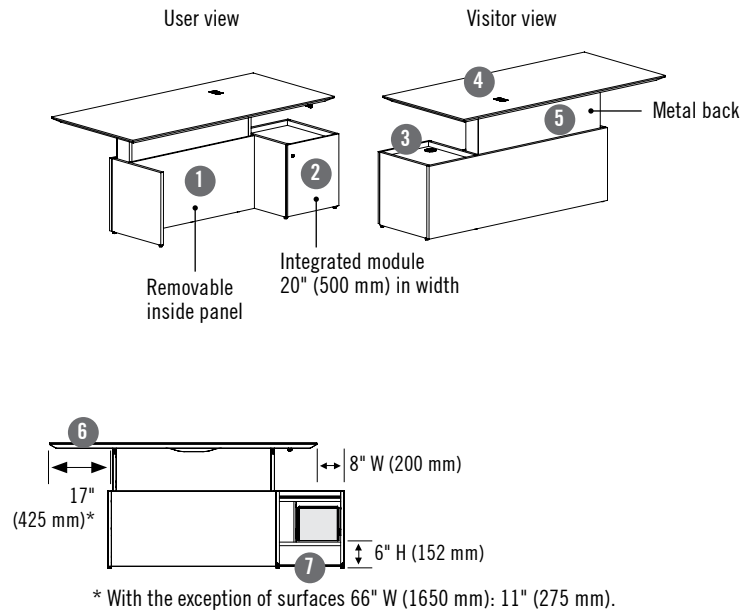

Height adjustment range:

1½" (38 mm) TOP	
Minimal position	26" (661 mm)
Maximum position	43½" (1105 mm)

Clearance for knees

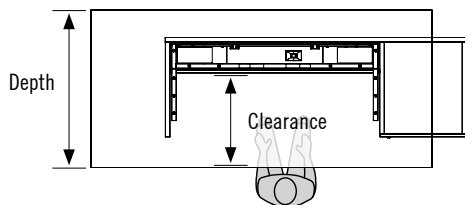

36" D (900 mm) = 21½" (538 mm) clearance
 32" D (800 mm) = 20½" (513 mm) clearance

ELECTRIC HEIGHT ADJUSTABLE DESKS (cont'd)

Choice of integrated modules

Electric height adjustable desks with file module

- Open compartment on top can accommodate small personal items.
- File drawer with suspension bar and lock.
- 4" L x 12" H (100 x 297 mm) hidden storage space to the right of the drawer.

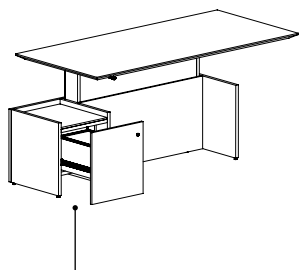

File storage module with small hidden space to the right of the file drawer

Electric height adjustable desks with fixed module

- Open compartment on top can accommodate small personal items.
- Closed /fixed storage space with removable front panel to access cables.
- 20" D (519 mm) storage module may be positioned facing the fixed module.

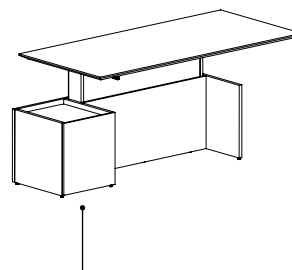

Closed /fixed module with removable front panel

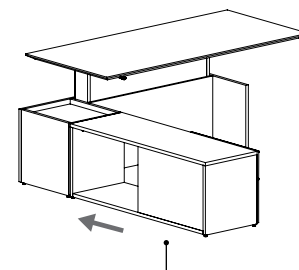

20" D (519 mm) storage module positioned in front of fixed module

Layout recommendations

For certain types of layout with a storage module positioned on top of a low storage module attached to the height adjustable desk, it is important to leave a minimum 8" D (200 mm) spacing in order to avoid impacts during lifting or lowering of the surface.

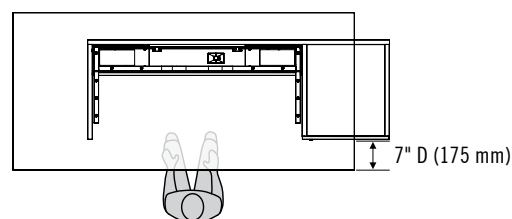

Possible configuration:

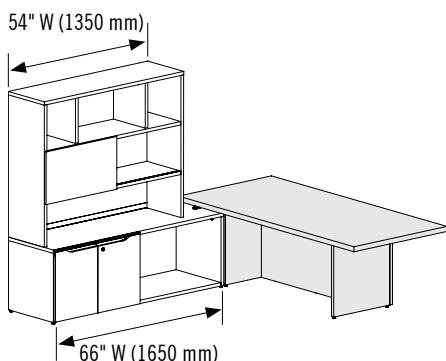

Unauthorized configurations:

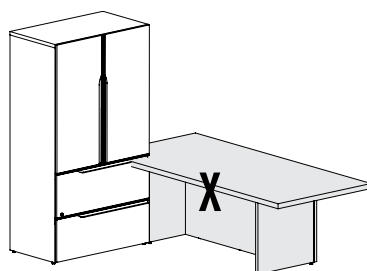

It is not possible to attach top storage modules to the integrated module of height adjustable desks.

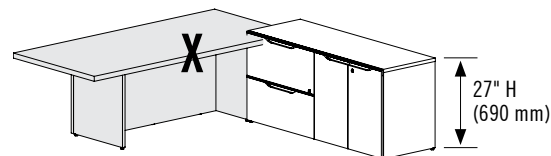

It is not possible to attach a 27" H (690 mm) storage module or a cabinet taller than 21" H (561 mm) to height adjustable desks.

ELECTRIC HEIGHT ADJUSTABLE DESKS WITH RETURN

NEX electric height adjustable desks with return are very easy to use, favor an active mode of work (sitting / standing) and can be adapted to users of different heights.

General characteristics

- 1- The laminate back is removable and enables access to the power cable.
- 2- The front panel of the integrated module may have a laminate or high-gloss black or high-gloss white finish.
- 3- Optional grommets on the surface available as a Standard Special (see p. 15).
- 4- Metal backs are available in a choice of Black or White accent color.
- 5- Cantilevered meeting place with a 10" (250 mm) span.
- 6- Full-width clearance for knees.
- 7- A 6" (152 mm) vertical x 6" (150 mm) deep clearance beneath the desk accommodates a floor monument.
- 8- 1" (25 mm) clearance around the surface.

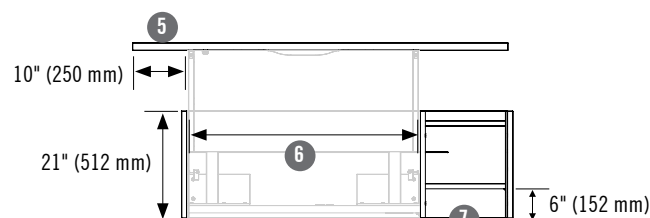
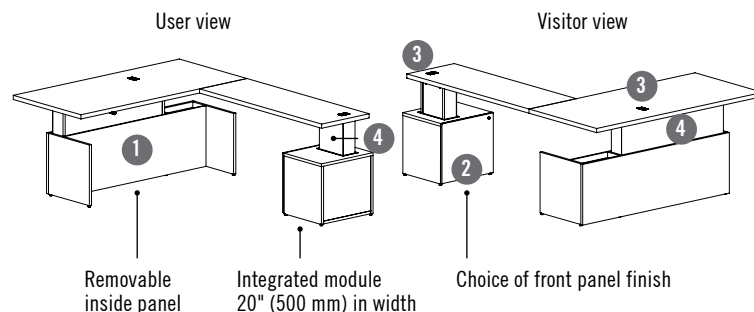

* This view does not show the return

ELECTRIC HEIGHT ADJUSTABLE DESKS WITH RETURN (cont'd)

Electric height adjustment

- Control keypad is installed beneath the work surface.
- Operating speed: 1¼" (32 mm) height adjustment per second.
- Sound level: 48 dB.
- Lift capacity of 2 columns: 264 lbs (120 kg).
- Lift capacity of 3 columns: 330 lbs (150 kg).
- Recommended functional load capacity: 100 lbs (45 kg).
- Failure to respect the loads can cause the table/desk to malfunction.
- 120" (3048 mm) cable with plug for wall outlet. 6' (1829 mm) of connector cable available outside the desk.
- Meet CSA and UL standards.

Height adjustment range:

1½" (38 mm) TOP	
Minimal position	26" (661 mm)
Maximum position	43½" (1105 mm)

Clearance for knees

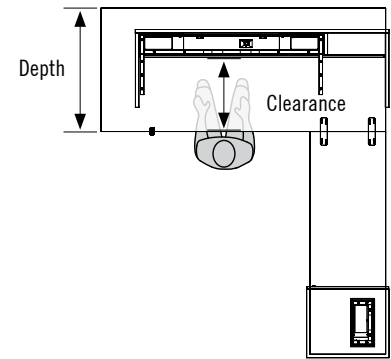

36" D (900 mm) = 21½" (538 mm) clearance
 32" D (800 mm) = 20½" (512 mm) clearance



Digital control keypad with memory

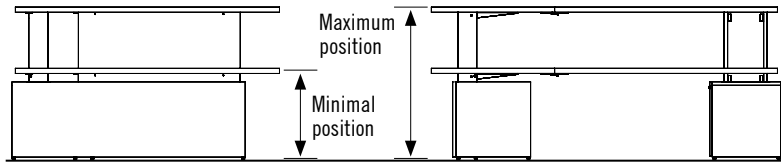

Electric height adjustment desks with return and storage module with file drawer

- Open compartment on top of storage module can accommodate small personal items.
- File drawer with suspension bar and lock.
- Access to cables.

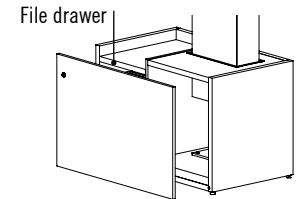
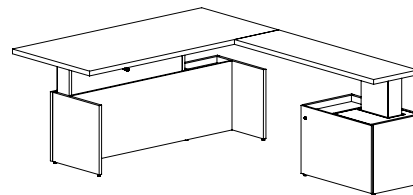

Electric height adjustable desks with return and fixed module

- Module with "push-to-open/close" door (without handle) 20" D (519 mm) enabling access to cables, including a small, 6" (150 mm) or 10" (250 mm) storage space.
- A 20" D (519 mm) storage module may be positioned facing the fixed module.
- Return-surfaces are 2" (50 mm) narrower than the integrated module. An 18" D (450 mm) return will therefore have a 20" D (519 mm) integrated module, while a 22" D (550 mm) return will have a 24" D (619 mm) integrated module.

It is possible to place a 20" D (457 mm) / 24" D (619 mm) storage module with the file module.

Return-surface with integrated module
 20" D (519 mm)

Return-surface with integrated module
 24" D (619 mm)

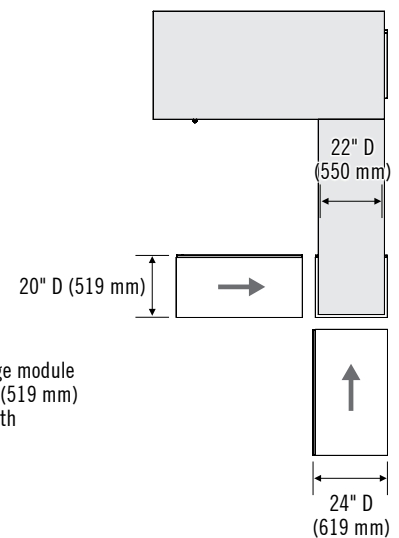
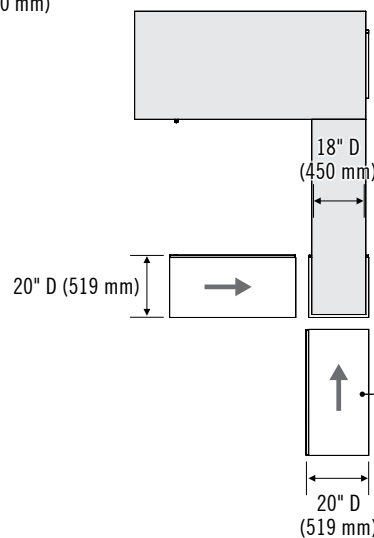
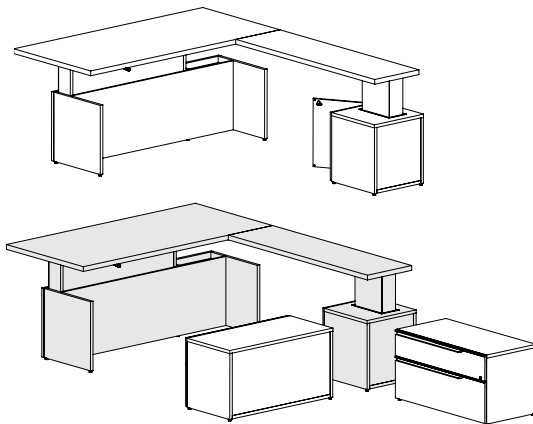

ELECTRIC HEIGHT ADJUSTABLE DESKS WITH RETURN (cont'd)

Electric height adjustable desks with return are sold combined with return-surfaces and integrated modules. Here is a description of the combinations available:

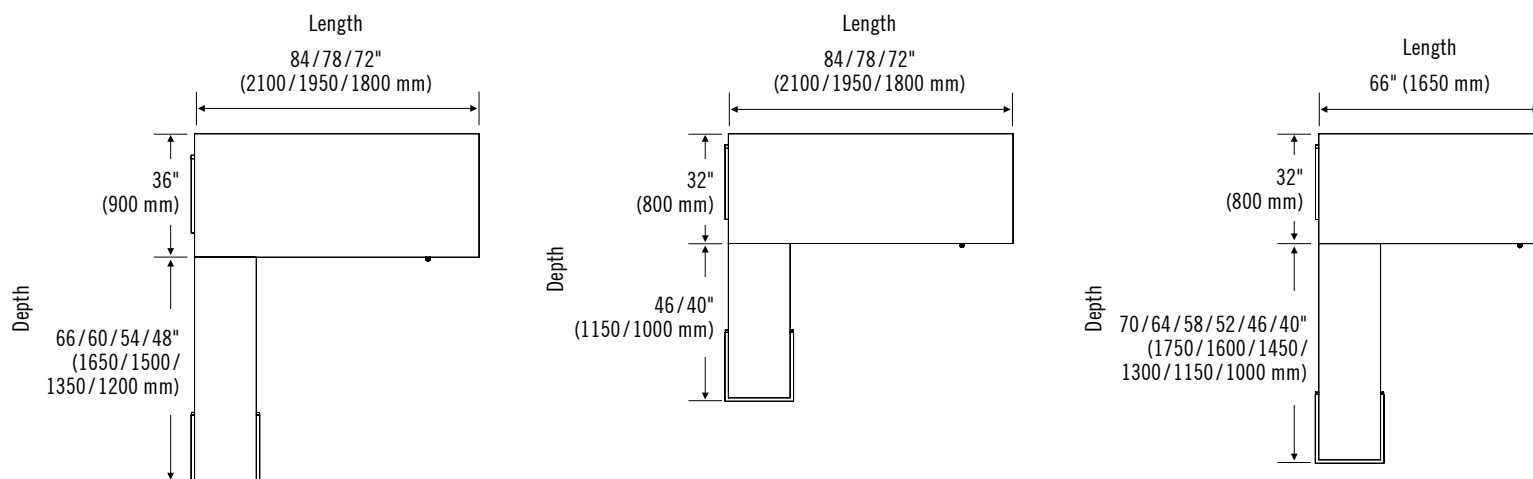

Layout recommendations

Calculate the space available underneath the return-surface. Height adjustable table, return-surfaces with integrated file module.

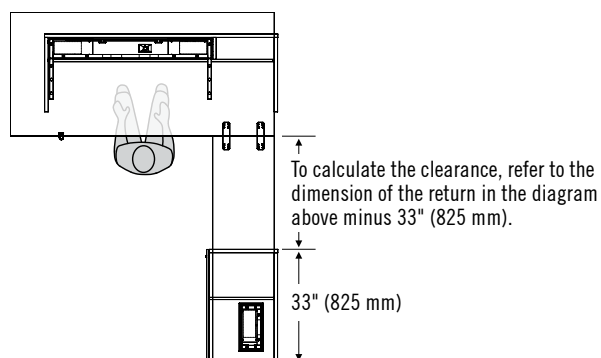

Height adjustable table, surface-returns with fixed module.

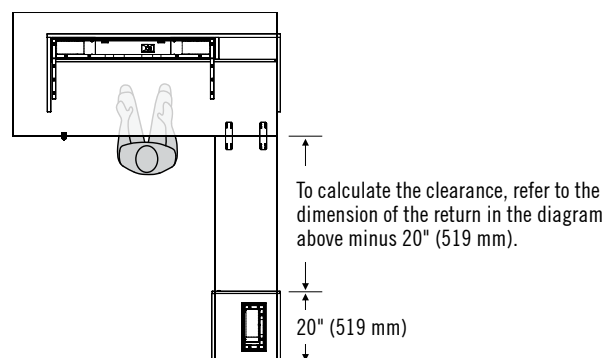

Possible configurations:

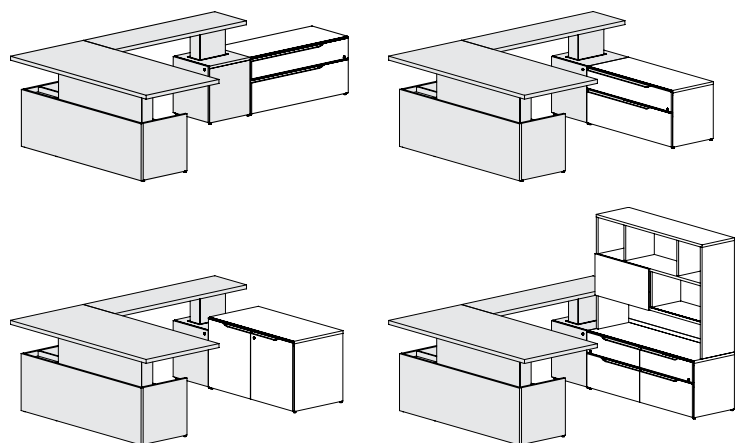

Unauthorized configurations:

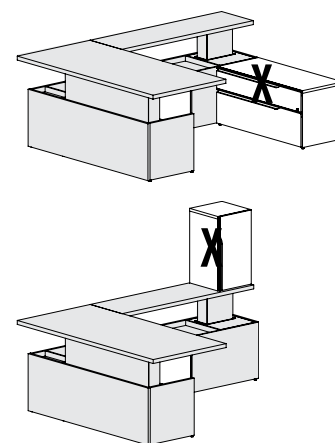

CAFÉ HEIGHT TABLES, MEETING TABLES AND COMPLEMENTARY FURNITURE

General characteristics

All meeting tables, café height tables, occasional tables and benches from the NEX collection are available with a choice of top panel 1" (25 mm) thick with smooth edgebanding or 1½" (38 mm) thick with smooth or knife edge.

Table and bench legs are in 1½" (38 mm) thick laminate. Modesty panels and table backs can have a laminate or high-gloss black or high-gloss white finish.

- Optional grommets or electric module at center of surface or table available as a Standard Special (see p. 15).

Tables

42" H (1067 mm) café height tables

- 18" H (457 mm) modesty panel.
- Clearance for knees varies with table depth:
Tables 36" D (900 mm) = 12¼" (309 mm) clearance on either side.
Tables 30" D (750 mm) = 11¼" (281 mm) clearance on either side.
Tables 24" D (600 mm) = 20" (500 mm) clearance on either side.

Café height tables 24" D (600 mm)

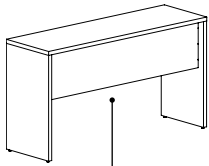

Modesty panel with 3" (75 mm) recess

Café height tables 30" D (750 mm)

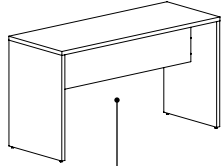

Centered modesty panels

Café height tables 36" D (900 mm)

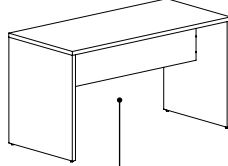

Centered modesty panels

29½" H (752 mm) meeting tables

- Full-height modesty panel, 1½" (38 mm) shorter with respect to the legs.
- Clearance for knees varies with table depth:
Tables 48" D (1200 mm) = 22" (550 mm) clearance on either side.
Tables 42" D (1050 mm) = 19" (475 mm) clearance on either side.
Tables 36" D (900 mm) = 16" (400 mm) clearance on either side.

Meeting tables 36/42/48" D (900/1050/1200 mm)

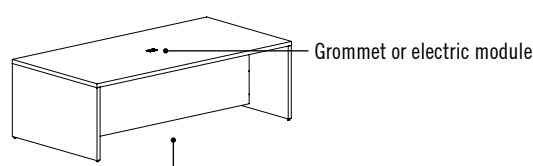

Centered modesty panels

Complementary furniture

Console tables

- Full-height modesty panel, 1½" (38 mm) shorter than the legs.
- Console tables are 29½" (752 mm) in height.
- Clearance on either side of modesty panels: 7" (175 mm).

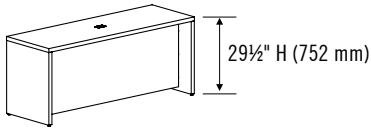

Benches

Benches are used alone or with 29½" H (752 mm) tables. They can accommodate cushions and a grommet on the side (available as Standard Specials, see p.15).

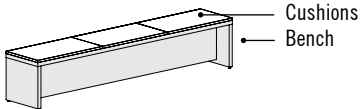

Coffee tables and magazine tables

- Full-height back, 1½" (38 mm) shorter with respect to the legs.
- Coffee tables are 18" (457 mm) in height.
- Magazine tables are 14" (356 mm) in height.

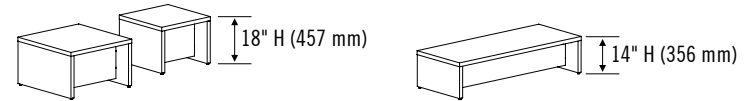

CUSHIONS

Cushions from the NEX collection add a touch of comfort and refinement to a work station. Cushions for 21" H (561 mm) storage modules and for benches are 1⅜" (35 mm) thick and attached using Velcro. They are available in a wide selection of upholstery; please consult www.groupelacasse.com.

Cushions for 21" H (561 mm) storage modules

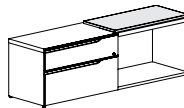

Cushions for benches

- To completely cover the surface of the bench, 3 cushions are needed.

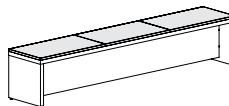

STORAGE FURNITURE

General characteristics

The different storage modules from the NEX collection can be used alone, as supports for surfaces or as occasional seats. The front panels and the doors cover the outer sides, the top and the bottom. The integrated back ensures sturdiness and provides a perfect finish. Drawers have a pencil tray, and file drawers have a suspension bar.

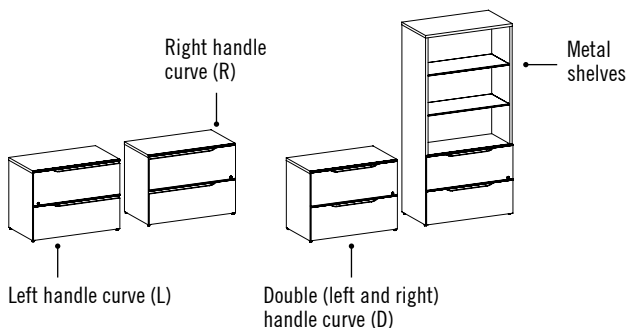

Handle options

For the front panels of drawers of most of the storage modules, it is possible to specify the orientation of the handle curve: left, right or both (double). An asymmetrical handle lends furniture a touch of sophistication. To achieve the desired design effect, carefully select the handle orientation during specification.

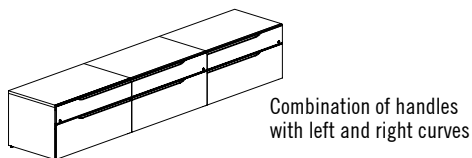

Front panel options

Front panels are available with a laminate or high-gloss black or high-gloss white finish.

Doors

The doors of storage modules have 105° soft-close hinges.

21" (561 mm) and 27" H (690 mm) storage modules

21" H (561 mm) storage modules

- 21" H (561 mm) storage modules are available in different depths. They can be used as supports for surfaces with short legs.
- Modules with an open bookcase have no back.

Several configurations available:

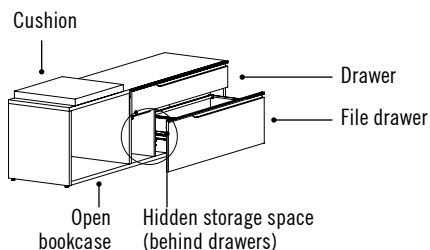
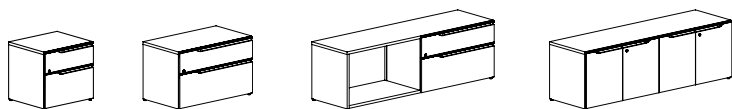

CPU storage module

Top and lateral grommets enable wire management inside the storage space.

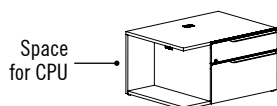

Locks

Key lock with silver accent. Identical cylinders available as an option: contact Customer Service. The lock locks all drawers or doors. No lock on the top drawer of 27" H (690 mm) storage modules and on shelves.

Metal shelf option

Cabinets and bookcases are available with optional metal shelves (front shelves):

- Thin, ½" (12 mm) thick shelf, 15" (375 mm) deep.
- Made of sturdy, 16-gauge steel.
- 2 colors available: Black (K) or White (W).
Cabinets with a 20" D (500 mm) open bookcase have a double back and 15" D (375 mm) metal shelves only.

Drawers and file drawers

- Telescopic, 16" (406 mm) full-extension slides with ball-bearing suspensions. Load capacity: 75 lb (34 kg) with slow close.
- 16" W (409 mm) storage modules, with soft-close drawers. Slow-close slides.
- For modules wider than 16" (409 mm), only the drawer has slow-close slides.

Lateral file drawers

- Double telescopic, 16" (406 mm) extension slides with ball-bearing suspensions. Load capacity: 150 lb (68 kg).

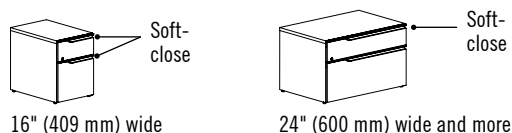

Levelers

- Standard on all furniture, levelers enable a height adjustment of 1¼" (32 mm). With the exception of two-sided bookcases, whose levelers enable a height adjustment of ¾" (19 mm).

27" H (690 mm) storage modules

- 27" H (690 mm) storage modules are available in 20" and 24" D (519 and 619 mm) models only. They can be used as supports for raised surfaces. (Module depth must be equal or greater than that of the surface.)
- Modules with an open bookcase have no back.

Several configurations available:

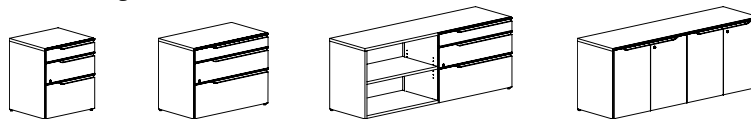

SPECIFICATIONS

STORAGE FURNITURE (cont'd)

Cabinets and bookcases

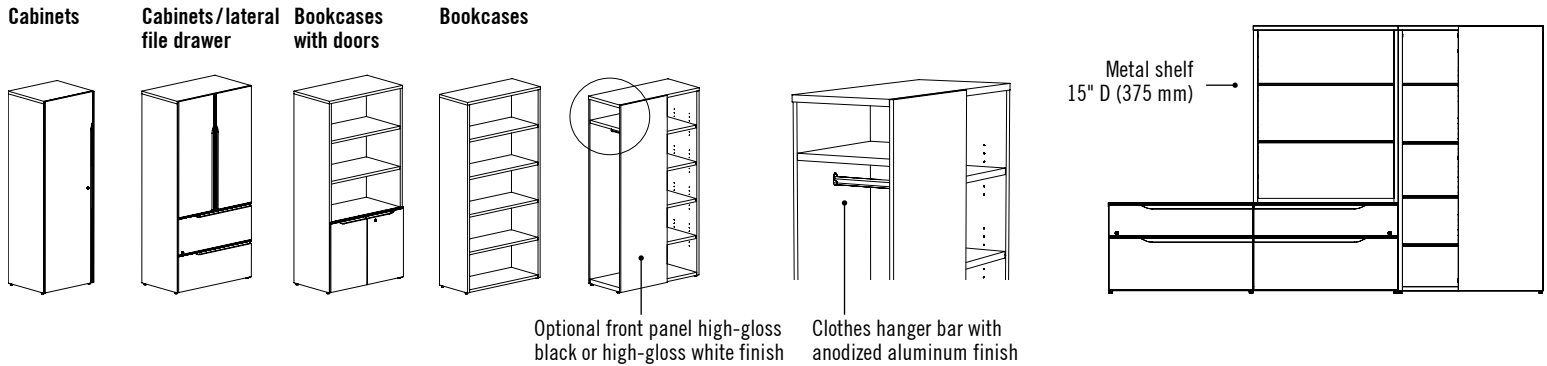

Hutches

Bookcase hutches

- Placed on top of storage modules, their installation requires double-sided tape.
- Can accommodate a bulletin board on the back.
- Doors have slow-close 105° hinges.
- Optional metal shelves for single- or double-sided open bookcases (front shelves). Bookcases 20" (500 mm) deep have a double back and 15" (375 mm) deep metal shelves only.

Hutches

- Placed on top of storage modules, their installation requires double-sided tape.
- Free space can accommodate a tackboard.
- Full-width cable access.
- Sliding doors do not have a slow-close effect.

Bookcases with doors

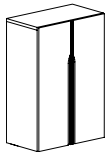

Bookcases with sliding door

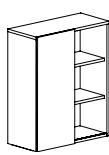

Bookcases

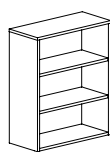

Double-sided bookcases

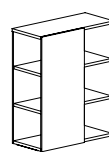

44" H (1098 mm) shelves with sliding door

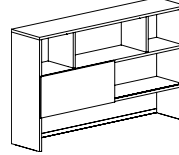

36" H (907 mm) shelves with sliding door

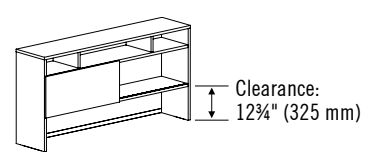

Wall-mounted shelves

- Wall-mounting hardware included.
- Compatible with standard wall-mounted tackboards from the current Lacasse general price book.

Bookcase hutches with doors

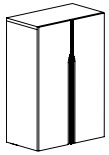

Soft-close doors

Wall-mounted hutches with lift-up door

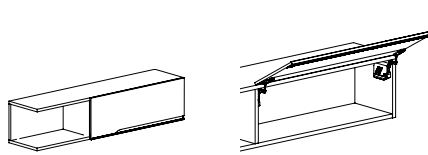

Assisted-opening, soft-close doors

Wall-mounted hutches with sliding door

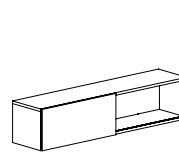

Sliding doors are not soft-closing.

MEDIA PANELS

General characteristics

Media panels enable the integration of a flat screen into a work station and the set-up of collaborative spaces and work rooms. Media panels are 7" (185 mm) deep and are placed on top of 21" or 27" H (561 or 690 mm) storage modules or 29½" H (752 mm) tables. They are delivered pre-assembled and are installed using double-sided tape and metal fasteners (included). The fasteners are attached beneath a storage module or the laminate leg of a table.

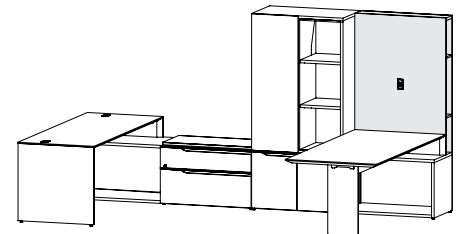
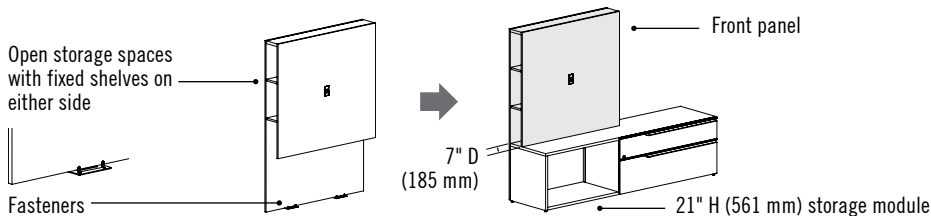

MEDIA PANELS (cont'd)

Flat-screen support and cable management

The front panel is designed to accommodate a support for a non-articulated flat screen. The installation area for such a support is solidified and its width varies according to the dimensions of the media panel. Check the width corresponding to the dimensions of the media panel selected before choosing your flat-screen support.

Wires pass through from top to bottom, left to right and front to back thanks to numerous grommets. Depending on the configuration and components of the work station and according to the electronic devices used, additional holes may need to be drilled for the passing of wires (on top or at back of the storage module) during installation.

Solidified installation area for accommodating a support for a flat screen

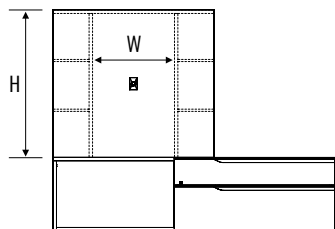

(W) Width of the fastening strip:
 Media panel 48" W (1200 mm) = 24" W (610 mm)
 Media panel 42" W (1050 mm) = 18" W (460 mm)
 Media panel 36" W (900 mm) = 12" W (310 mm)
 (H) Vertical clearance:
 The height of the media panel minus the height of the furniture accommodating it.

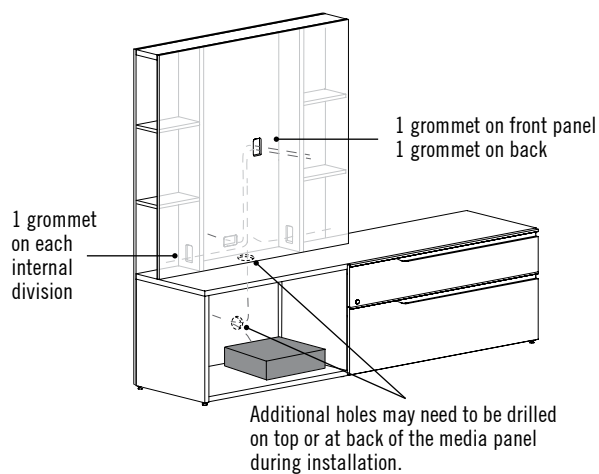

Possible configurations:

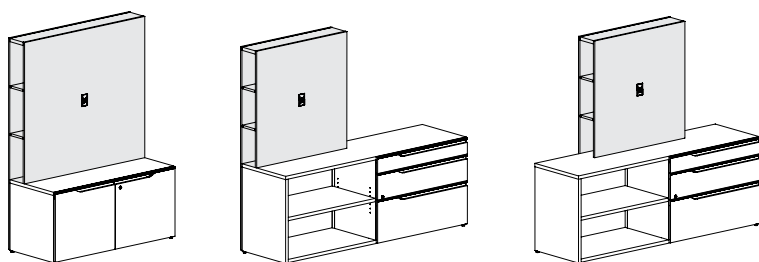

The media panel is installed on top of a 21" or 27" H (561 or 690 mm) storage module of the same width or wider. Modules with drawers do not allow the passage of wires.

Unauthorized configurations:

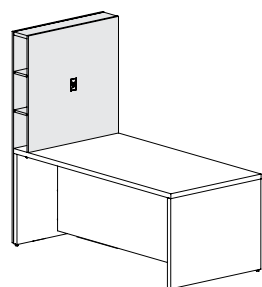
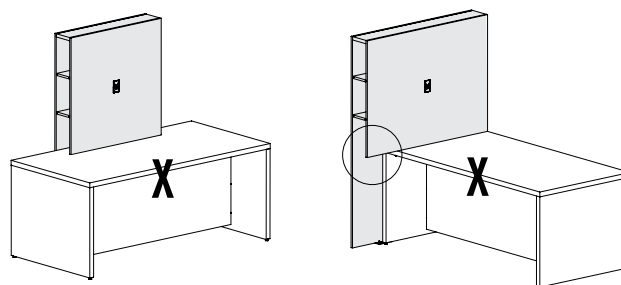

The media panel is installed on a 29½" H (752 mm) table or work surface of the same size and only on the laminate leg.

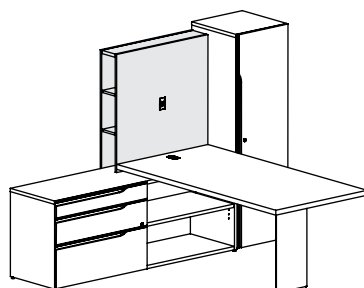

A 21" or 27" H (561 or 690 mm) storage module with media panel can accommodate a surface placed on it directly or raised with a strut.

MODULAR PRIVACY SCREENS

Modular privacy screens are 24" or 30" (600 or 750 mm) in height and are installed on surfaces, desks and returns. They must be installed on the side opposite to the user and cannot be installed on the sides of legs. Available in frosted acrylic or in fabric.

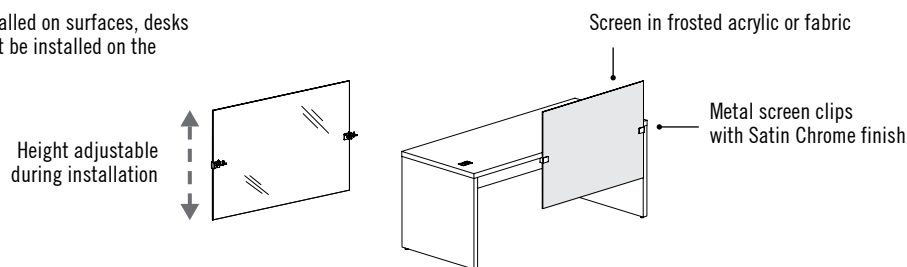

ACCESSORIES

Modular modesty panels

Modesty panels are 14" (350 mm) in height and are installed beneath all surfaces with a short back, beneath surfaces raised with one or more struts, and beneath the return-surface of height adjustable desks with returns.

They must be installed on the side opposite to the user and cannot be installed on the sides of legs. A modesty panel may be positioned anywhere, but must always be smaller in size than the desk or surface that accommodates it. Available in laminate or high-gloss black or high-gloss white finish.

MOD modesty panels

- Compatible with desks and returns with a 6" H (150 mm) back.

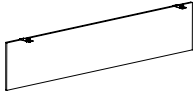

Possible configurations:

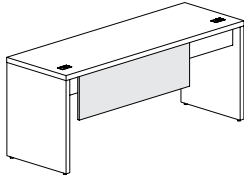
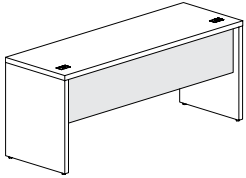

With an N5NNN-RT2472A5 desk, specify modesty panel NNNNN-MOD1469 (full width) or NNNNN-MOD1445 (smaller size).

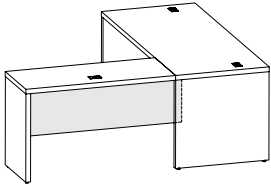

With an N5NRN-R2048A5 return and an N5NNN-RT3072A5 surface, specify modesty panel NNNNN-MOD1449. The modesty panel may be shorter or longer than the return (it is extended underneath the surface).

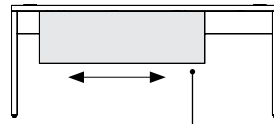

Laminate or High-Gloss Black or High-Gloss White

MODS modesty panels

- Compatible with elevated surfaces and the returns of height adjustable desks.
- Silver accent fasteners.

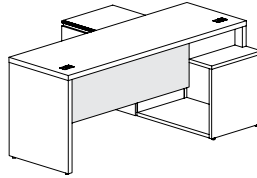

With an N5NRN-RS2472B5 desk and an N1NRW-UL206021BE storage module, specify modesty panel NNNNN-MOD1449.

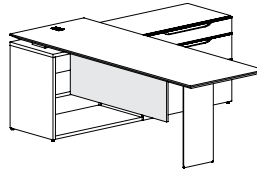

With an N5KNN-RS3084PD6 desk and an N1NDN-BE207227LUF storage module, specify modesty panel NNNNN-MODS1445 (or a smaller size).

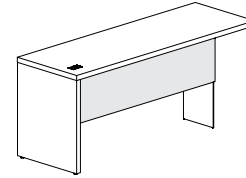

With an N5NRN-RS2472PA5 desk, specify modesty panel NNNNB-MOD1457. The slim metal leg always has a 13" (340 mm) recess.

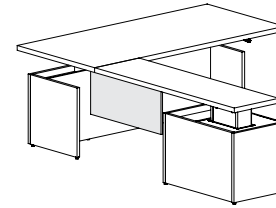

With an N5NLN-RTL7810220FG desk, specify modesty panel NNNNN-MODS1433. To calculate the space available, refer to the section on height adjustable desks with returns, on page 9.

Complementary accessories

- Clamp and grommet mount flat screen supports that are compatible with the Nex collection are available in the current Lacasse general price book. The clip fastener is not compatible with surfaces that have knife edgebanding.
- Keyboard support LGC-SKD26 is not compatible with surfaces 20" (500 mm) deep.
- Keyboard supports LGC-BBAKD26 and LGC-GBAKD26 are not compatible with surfaces 20" (500 mm), 24" (600 mm) and 30" (752 mm) deep.

- The short and long accessory supports LGC-SUPAC_ and LGC-SUPAL_ are not compatible with surfaces and desks that have knife edgebanding.

Several electric and communication accessories compatible with the NEX collection are available. Consult the Accessoires section of the current Lacasse general price list.

APPLICATION OF TWO-TONE AND HIGH-GLOSS FINISHES

Two-tone laminate application: Shaded area corresponds to the first code to be specified. Second laminate code will be applied to the rest of the product.

Surfaces: First finish specified will be applied to the tops and the legs. Second finish specified will be applied to the back. For height adjustable surfaces, the first finish will be applied on the top of the surface, and the second on the base.

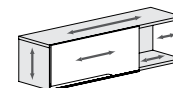
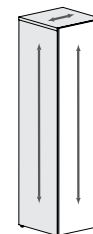
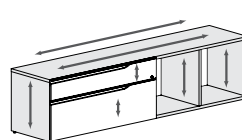
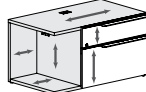
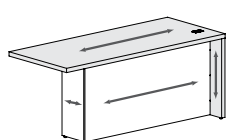
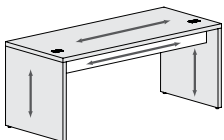

Storage modules: First finish specified will be applied to the frame, and the second to the front panel.

Two-tone application and direction of wood grain:

APPLICATION OF TWO-TONE AND HIGH-GLOSS FINISHES (cont'd)

Application of high-gloss black and high-gloss white finish for desks, modesty panels and storage modules.

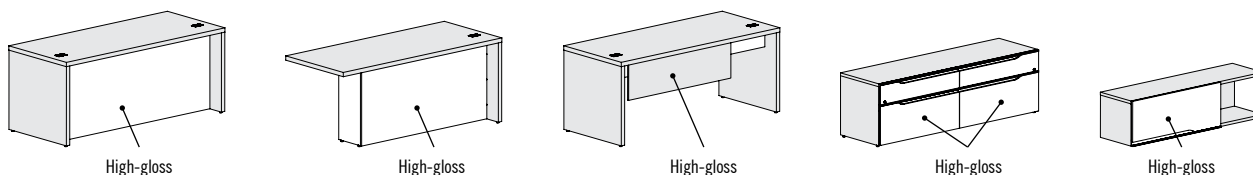

Examples of codes:

CORRECT N1NRN-UL206021BE CCL/SNO

CORRECT N1NRW-UL206021BE CCL (The W indicates that the front panels will have a High-Gloss White finish.)

WRONG N1NRW-UL206021BE CCL/SNO (The W indicates that the front panels will have a High-Gloss White finish. It is therefore not possible to specify a Snow (SNO) color as a second finish.)

STANDARD SPECIALS

Groupe Lacasse allows certain modifications to be made to standard furniture without the need for filing a request with the Specials department, among them, the addition, modification or removal of a grommet and the addition of a wireless charger (LGC-CHARGE).

Other standard special modifications are available. Consult the current Lacasse general price list.

CODE	TYPE OF GROMMET	CODE AND POSITION		
		Left	Center	Right
MGRQ25	Rectangular – satin chrome finish for surfaces 1" (25 mm) thick	_MGRQ25L	_MGRQ25C	_MGRQ25R
MGRQ38	Rectangular – satin chrome finish for 1½" (38 mm) thick	_MGRQ38L	_MGRQ38C	_MGRQ38R
GR9	Type to be specified	Must be accompanied with a drawing indicating the precise position required.		
CHARGE	Wireless charger (LGC-CHARGE)	Must be accompanied with a drawing indicating the precise position required, except for height adjustable desks.		

Addition, modification or removal of a grommet

- Add the letter "S" before the product code.
- Add the code for the desired position to the product description (refer to table).
- Insert the modification code (A, M, R) at the start of the product code.
A: Addition; M: Modification; R: Removal.

Add surcharge for grommet modification.*

Addition of a metal grommet in standard position:	\$122.00
Addition of a grommet from another collection in non-standard position:	\$81.00
Modification of an existing grommet's position:	\$0.00
Removal or replacement of an existing grommet:	\$0.00
Addition of a cut-out for the wireless charger module (module not included):	\$0.00

*For electric height adjustable desks as well as for benches, grommets and electric modules are added at predetermined positions, according to the build of the furniture piece.

SPECIFICATION OF OPTIONS AND FINISHES

EDGEBANDING

Automatically applied to the top and to the sides.

N Edge



1" and 1½"
(25 and 38 mm)

N edgebanding matches the finish specified for the surface.

K Knife edge

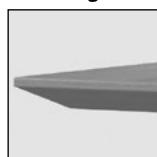

1½"
(38 mm)

K knife-edge available (in coordinated colors) ONLY when a wood grain or SNO or NCN finish is specified for the surface.

HIGH-GLOSS FINISHES



B – High-Gloss Black

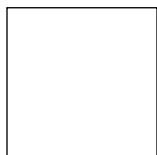

W – High-Gloss White

The application of a High-Gloss White or High-Gloss Black finish for desks, modesty panels and storage modules is the same as the application of the second tone.

METAL COMPONENTS

Polished Chrome finish

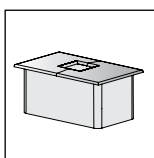

Grommet cover

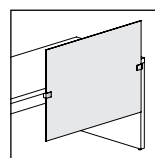

Modular screen support

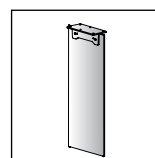

Slim metal leg

ACCESSORIES

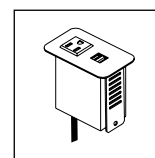

LGC-PCQ1USB1P

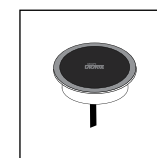

LGC-CHARGE

The opening of the grommet can accommodate an electric module with metallic silver accent.

HANDLES

Anodized aluminum

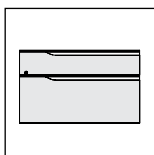

L – Left

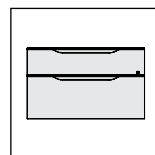

D – Double

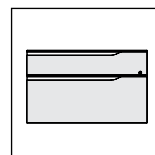

R – Right

FABRIC

Various fabric choices are available. Refer to the current Lacasse upholstery selection guide at www.grounelacasse.com.

CODIFICATION

Series	Thickness	Options					Options
		Edgebanding	Handles	High-gloss accent	Dash	Product	
N	1 Thermofused laminate 1" (25 mm)	N Smooth edge	L Left	B High-Gloss Black	-		K Back / Shelves in black metal W Back / Shelves in white metal
	2 High-pressure laminate 1" (25 mm)	K Knife edge	R Right	W High-Gloss White			
	5 Thermofused laminate 1½" (38 mm)		D Double				
	6 High-pressure laminate 1½" (38 mm)						

DESKS

Rectangular desks, full modesty panel, 2 long legs – 36" D

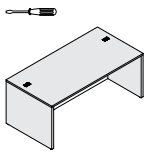

High-Gloss Black (B) or High-Gloss White (W) modesty panel finish option: add \$402.

W x D x H (in)	W x D x H (mm)	Code	All Laminate (\$)	HPL Surfaces (\$)
<i>9" (225 mm) recessed full-height modesty panel. 2 grommets. Can accommodate 1 or 2 pedestals NNN --161820F or NNN --MP161820F.</i>				
72 x 36 x 29½	1800 x 900 x 752	N_NN-RT3672A	1,289	1,654
66 x 36 x 29½	1650 x 900 x 752	N_NN-RT3666A	1,219	1,525
60 x 36 x 29½	1500 x 900 x 752	N_NN-RT3660A	1,152	1,402
Specify the surface type (1, 2). Specify the modesty panel finish (B, W, N).				
72 x 36 x 29½	1800 x 900 x 752	N_NN-RT3672A	1,419	1,772
66 x 36 x 29½	1650 x 900 x 752	N_NN-RT3666A	1,329	1,628
60 x 36 x 29½	1500 x 900 x 752	N_NN-RT3660A	1,232	1,490

Specify the surface type (5, 6). Specify the modesty panel finish (B, W, N).

72 x 36 x 29½	1800 x 900 x 752	N_KN-RT3672A	2,135	2,491
66 x 36 x 29½	1650 x 900 x 752	N_KN-RT3666A	2,008	2,314
60 x 36 x 29½	1500 x 900 x 752	N_KN-RT3660A	1,882	2,135

Knife edge (K). Specify the surface type (5, 6). Specify the modesty panel finish (B, W, N).

Rectangular desks, full modesty panel, 2 long legs – 30" D

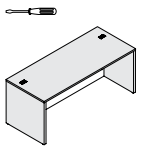

High-Gloss Black (B) or High-Gloss White (W) modesty panel finish option: add \$402.

W x D x H (in)	W x D x H (mm)	Code	All Laminate (\$)	HPL Surfaces (\$)
<i>6" (150 mm) recessed full-height modesty panel. 2 grommets. Can accommodate 1 or 2 pedestals NNN --161820F or NNN --MP161820F.</i>				
72 x 30 x 29½	1800 x 750 x 752	N_NN-RT3072A	1,225	1,564
66 x 30 x 29½	1650 x 750 x 752	N_NN-RT3066A	1,182	1,482
60 x 30 x 29½	1500 x 750 x 752	N_NN-RT3060A	1,138	1,395
Specify the surface type (1, 2). Specify the modesty panel finish (B, W, N).				
72 x 30 x 29½	1800 x 750 x 752	N_NN-RT3072A	1,345	1,690
66 x 30 x 29½	1650 x 750 x 752	N_NN-RT3066A	1,289	1,585
60 x 30 x 29½	1500 x 750 x 752	N_NN-RT3060A	1,232	1,482

Specify the surface type (5, 6). Specify the modesty panel finish (B, W, N).

72 x 30 x 29½	1800 x 750 x 752	N_KN-RT3072A	2,062	2,401
66 x 30 x 29½	1650 x 750 x 752	N_KN-RT3066A	1,974	2,264
60 x 30 x 29½	1500 x 750 x 752	N_KN-RT3060A	1,877	2,135

Knife edge (K). Specify the surface type (5, 6). Specify the modesty panel finish (B, W, N).

Rectangular desks, short back, 2 long legs – 36" D

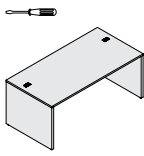

W x D x H (in)	W x D x H (mm)	Code	All Laminate (\$)	HPL Surfaces (\$)
<i>9" (225 mm) recessed short back. 2 grommets. Can accommodate 1 or 2 storage modules and 1 modular modesty panel.</i>				
78 x 36 x 29½	1950 x 900 x 752	N_NNN-RT3678A5	1,345	1,738
72 x 36 x 29½	1800 x 900 x 752	N_NNN-RT3672A5	1,322	1,676
66 x 36 x 29½	1650 x 900 x 752	N_NNN-RT3666A5	1,289	1,621
60 x 36 x 29½	1500 x 900 x 752	N_NNN-RT3660A5	1,264	1,564
Specify the surface type (1, 2).				
78 x 36 x 29½	1950 x 900 x 752	N_NNN-RT3678A5	1,459	1,847
72 x 36 x 29½	1800 x 900 x 752	N_NNN-RT3672A5	1,426	1,780
66 x 36 x 29½	1650 x 900 x 752	N_NNN-RT3666A5	1,384	1,716
60 x 36 x 29½	1500 x 900 x 752	N_NNN-RT3660A5	1,345	1,640

Specify the surface type (5, 6).

78 x 36 x 29½	1950 x 900 x 752	N_KNN-RT3678A5	1,829	2,210
72 x 36 x 29½	1800 x 900 x 752	N_KNN-RT3672A5	1,780	2,144
66 x 36 x 29½	1650 x 900 x 752	N_KNN-RT3666A5	1,749	2,071
60 x 36 x 29½	1500 x 900 x 752	N_KNN-RT3660A5	1,716	2,008

Knife edge (K). Specify the surface type (5, 6).

Rectangular desks, short back, 2 long legs – 30" D

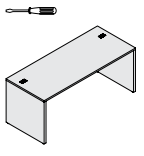

W x D x H (in)	W x D x H (mm)	Code	All Laminate (\$)	HPL Surfaces (\$)
<i>6" (150 mm) recessed short back. 2 grommets. Can accommodate 1 or 2 storage modules and 1 modular modesty panel.</i>				
78 x 30 x 29½	1950 x 750 x 752	N_NNN-RT3078A5	1,256	1,585
72 x 30 x 29½	1800 x 750 x 752	N_NNN-RT3072A5	1,225	1,530
66 x 30 x 29½	1650 x 750 x 752	N_NNN-RT3066A5	1,201	1,482
60 x 30 x 29½	1500 x 750 x 752	N_NNN-RT3060A5	1,176	1,426
Specify the surface type (1, 2).				
78 x 30 x 29½	1950 x 750 x 752	N_NNN-RT3078A5	1,345	1,660
72 x 30 x 29½	1800 x 750 x 752	N_NNN-RT3072A5	1,317	1,612
66 x 30 x 29½	1650 x 750 x 752	N_NNN-RT3066A5	1,282	1,546
60 x 30 x 29½	1500 x 750 x 752	N_NNN-RT3060A5	1,242	1,499

Specify the surface type (5, 6).

78 x 30 x 29½	1950 x 750 x 752	N_KNN-RT3078A5	1,709	2,029
72 x 30 x 29½	1800 x 750 x 752	N_KNN-RT3072A5	1,669	1,967
66 x 30 x 29½	1650 x 750 x 752	N_KNN-RT3066A5	1,635	1,918
60 x 30 x 29½	1500 x 750 x 752	N_KNN-RT3060A5	1,612	1,854

Knife edge (K). Specify the surface type (5, 6).

Rectangular desks, short back, 2 long legs – 24" D

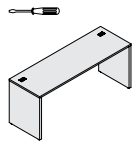

3" (75 mm) recessed short back. 2 grommets. Can accommodate 1 or 2 storage modules and 1 modular modesty panel.

W x D x H (in)	W x D x H (mm)	Code	All Laminate (\$)	HPL Surfaces (\$)
72 x 24 x 29½	1800 x 600 x 752	N_NNN-RT2472A5	1,138	1,379
66 x 24 x 29½	1650 x 600 x 752	N_NNN-RT2466A5	1,114	1,329
60 x 24 x 29½	1500 x 600 x 752	N_NNN-RT2460A5	1,096	1,289
54 x 24 x 29½	1350 x 600 x 752	N_NNN-RT2454A5	1,071	1,256
48 x 24 x 29½	1200 x 600 x 752	N_NNN-RT2448A5	1,047	1,211

Specify the surface type (1, 2).

72 x 24 x 29½	1800 x 600 x 752	N_NNN-RT2472A5	1,201	1,434
66 x 24 x 29½	1650 x 600 x 752	N_NNN-RT2466A5	1,176	1,384
60 x 24 x 29½	1500 x 600 x 752	N_NNN-RT2460A5	1,138	1,335
54 x 24 x 29½	1350 x 600 x 752	N_NNN-RT2454A5	1,114	1,298
48 x 24 x 29½	1200 x 600 x 752	N_NNN-RT2448A5	1,088	1,242

Specify the surface type (5, 6).

72 x 24 x 29½	1800 x 600 x 752	N_KNN-RT2472A5	1,557	1,786
66 x 24 x 29½	1650 x 600 x 752	N_KNN-RT2466A5	1,530	1,749
60 x 24 x 29½	1500 x 600 x 752	N_KNN-RT2460A5	1,506	1,702
54 x 24 x 29½	1350 x 600 x 752	N_KNN-RT2454A5	1,482	1,654
48 x 24 x 29½	1200 x 600 x 752	N_KNN-RT2448A5	1,445	1,605

Knife edge (K). Specify the surface type (5, 6).

Rectangular desks, short back, 2 long legs – 20" D

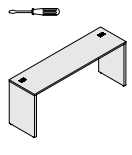

3" (75 mm) recessed short back. 2 grommets. Can accommodate 1 modular modesty panel.

W x D x H (in)	W x D x H (mm)	Code	All Laminate (\$)	HPL Surfaces (\$)
72 x 20 x 29½	1800 x 500 x 752	N_NNN-RT2072A5	1,088	1,282
66 x 20 x 29½	1650 x 500 x 752	N_NNN-RT2066A5	1,065	1,232
60 x 20 x 29½	1500 x 500 x 752	N_NNN-RT2060A5	1,047	1,201
54 x 20 x 29½	1350 x 500 x 752	N_NNN-RT2054A5	1,015	1,169
48 x 20 x 29½	1200 x 500 x 752	N_NNN-RT2048A5	993	1,119

Specify the surface type (1, 2).

72 x 20 x 29½	1800 x 500 x 752	N_NNN-RT2072A5	1,119	1,322
66 x 20 x 29½	1650 x 500 x 752	N_NNN-RT2066A5	1,096	1,282
60 x 20 x 29½	1500 x 500 x 752	N_NNN-RT2060A5	1,071	1,232
54 x 20 x 29½	1350 x 500 x 752	N_NNN-RT2054A5	1,054	1,201
48 x 20 x 29½	1200 x 500 x 752	N_NNN-RT2048A5	1,021	1,161

Specify the surface type (5, 6).

72 x 20 x 29½	1800 x 500 x 752	N_KNN-RT2072A5	1,490	1,676
66 x 20 x 29½	1650 x 500 x 752	N_KNN-RT2066A5	1,459	1,635
60 x 20 x 29½	1500 x 500 x 752	N_KNN-RT2060A5	1,434	1,605
54 x 20 x 29½	1350 x 500 x 752	N_KNN-RT2054A5	1,411	1,557
48 x 20 x 29½	1200 x 500 x 752	N_KNN-RT2048A5	1,384	1,518

Knife edge (K). Specify the surface type (5, 6).

WORK SURFACES

Rectangular surfaces, short back, 1 long and 1 short leg – 36" D

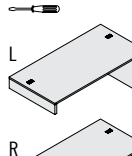

9" (225 mm) recessed short back. 2 grommets. Must use 1 storage module 21" H (561 mm) as support. Can accommodate 1 modular modesty panel.

W x D x H (in)	W x D x H (mm)	Code	All Laminate (\$)	HPL Surfaces (\$)
84 x 36 x 29½	2100 x 900 x 752	N_N_NN-RS3684B5	1,395	1,814
78 x 36 x 29½	1950 x 900 x 752	N_N_NN-RS3678B5	1,219	1,612
72 x 36 x 29½	1800 x 900 x 752	N_N_NN-RS3672B5	1,193	1,546
66 x 36 x 29½	1650 x 900 x 752	N_N_NN-RS3666B5	1,169	1,490
60 x 36 x 29½	1500 x 900 x 752	N_N_NN-RS3660B5	1,127	1,434

Specify the surface type (1, 2). Specify left (L) or right (R).

84 x 36 x 29½	2100 x 900 x 752	N_N_NN-RS3684B5	1,518	1,926
78 x 36 x 29½	1950 x 900 x 752	N_N_NN-RS3678B5	1,329	1,716
72 x 36 x 29½	1800 x 900 x 752	N_N_NN-RS3672B5	1,298	1,640
66 x 36 x 29½	1650 x 900 x 752	N_N_NN-RS3666B5	1,256	1,585
60 x 36 x 29½	1500 x 900 x 752	N_N_NN-RS3660B5	1,219	1,518

Specify the surface type (5, 6). Specify left (L) or right (R).

84 x 36 x 29½	2100 x 900 x 752	N_K_NN-RS3684B5	1,983	2,393
78 x 36 x 29½	1950 x 900 x 752	N_K_NN-RS3678B5	1,690	2,071
72 x 36 x 29½	1800 x 900 x 752	N_K_NN-RS3672B5	1,654	2,008
66 x 36 x 29½	1650 x 900 x 752	N_K_NN-RS3666B5	1,621	1,942
60 x 36 x 29½	1500 x 900 x 752	N_K_NN-RS3660B5	1,572	1,869

Knife edge (K). Specify the surface type (5, 6). Specify left (L) or right (R).

	W x D x H (in)	W x D x H (mm)	Code	All Laminate (\$)	HPL Surfaces (\$)
Rectangular surfaces, short back, 1 long and 1 short leg – 30" D	84 x 30 x 29½	2100 x 750 x 752	N_N_N-RS3084B5	1,317	1,660
	78 x 30 x 29½	1950 x 750 x 752	N_N_N-RS3078B5	1,138	1,475
	72 x 30 x 29½	1800 x 750 x 752	N_N_N-RS3072B5	1,114	1,419
	66 x 30 x 29½	1650 x 750 x 752	N_N_N-RS3066B5	1,088	1,371
	60 x 30 x 29½	1500 x 750 x 752	N_N_N-RS3060B5	1,065	1,317
	Specify the surface type (1, 2). Specify left (L) or right (R).				
Specify the surface type (1, 2). Specify left (L) or right (R).	84 x 30 x 29½	2100 x 750 x 752	N_N_N-RS3084B5	1,411	1,760
	78 x 30 x 29½	1950 x 750 x 752	N_N_N-RS3078B5	1,225	1,546
	72 x 30 x 29½	1800 x 750 x 752	N_N_N-RS3072B5	1,201	1,499
	66 x 30 x 29½	1650 x 750 x 752	N_N_N-RS3066B5	1,169	1,434
	60 x 30 x 29½	1500 x 750 x 752	N_N_N-RS3060B5	1,127	1,379
	Specify the surface type (5, 6). Specify left (L) or right (R).				
Specify the surface type (5, 6). Specify left (L) or right (R).	84 x 30 x 29½	2100 x 750 x 752	N_K_N-RS3084B5	1,877	2,224
	78 x 30 x 29½	1950 x 750 x 752	N_K_N-RS3078B5	1,597	1,918
	72 x 30 x 29½	1800 x 750 x 752	N_K_N-RS3072B5	1,557	1,854
	66 x 30 x 29½	1650 x 750 x 752	N_K_N-RS3066B5	1,525	1,786
	60 x 30 x 29½	1500 x 750 x 752	N_K_N-RS3060B5	1,499	1,738
	Knife edge (K). Specify the surface type (5, 6). Specify left (L) or right (R).				

	W x D x H (in)	W x D x H (mm)	Code	All Laminate (\$)	HPL Surfaces (\$)
Rectangular surfaces, short back, 1 long and 1 short leg – 24" D	72 x 24 x 29½	1800 x 600 x 752	N_N_N-RS2472B5	1,047	1,282
	66 x 24 x 29½	1650 x 600 x 752	N_N_N-RS2466B5	1,015	1,232
	60 x 24 x 29½	1500 x 600 x 752	N_N_N-RS2460B5	998	1,201
	54 x 24 x 29½	1350 x 600 x 752	N_N_N-RS2454B5	973	1,161
	48 x 24 x 29½	1200 x 600 x 752	N_N_N-RS2448B5	951	1,114
	Specify the surface type (1, 2). Specify left (L) or right (R).				
Specify the surface type (1, 2). Specify left (L) or right (R).	72 x 24 x 29½	1800 x 600 x 752	N_N_N-RS2472B5	1,102	1,335
	66 x 24 x 29½	1650 x 600 x 752	N_N_N-RS2466B5	1,071	1,289
	60 x 24 x 29½	1500 x 600 x 752	N_N_N-RS2460B5	1,047	1,242
	54 x 24 x 29½	1350 x 600 x 752	N_N_N-RS2454B5	1,015	1,193
	48 x 24 x 29½	1200 x 600 x 752	N_N_N-RS2448B5	993	1,152
	Specify the surface type (5, 6). Specify left (L) or right (R).				
Specify the surface type (5, 6). Specify left (L) or right (R).	72 x 24 x 29½	1800 x 600 x 752	N_K_N-RS2472B5	1,459	1,702
	66 x 24 x 29½	1650 x 600 x 752	N_K_N-RS2466B5	1,434	1,654
	60 x 24 x 29½	1500 x 600 x 752	N_K_N-RS2460B5	1,411	1,605
	54 x 24 x 29½	1350 x 600 x 752	N_K_N-RS2454B5	1,379	1,557
	48 x 24 x 29½	1200 x 600 x 752	N_K_N-RS2448B5	1,345	1,506
	Knife edge (K). Specify the surface type (5, 6). Specify left (L) or right (R).				

	W x D x H (in)	W x D x H (mm)	Code	All Laminate (\$)	HPL Surfaces (\$)
Rectangular surfaces, short back, 2 short legs – 36" D	84 x 36 x 7½	2100 x 900 x 191	N_NNN-RS3684C5	1,264	1,690
	78 x 36 x 7½	1950 x 900 x 191	N_NNN-RS3678C5	1,088	1,482
	72 x 36 x 7½	1800 x 900 x 191	N_NNN-RS3672C5	1,065	1,419
	66 x 36 x 7½	1650 x 900 x 191	N_NNN-RS3666C5	1,041	1,371
	60 x 36 x 7½	1500 x 900 x 191	N_NNN-RS3660C5	998	1,306
	Specify the surface type (1, 2).				
Specify the surface type (1, 2).	84 x 36 x 7½	2100 x 900 x 191	N_NNN-RS3684C5	1,384	1,786
	78 x 36 x 7½	1950 x 900 x 191	N_NNN-RS3678C5	1,201	1,585
	72 x 36 x 7½	1800 x 900 x 191	N_NNN-RS3672C5	1,161	1,518
	66 x 36 x 7½	1650 x 900 x 191	N_NNN-RS3666C5	1,119	1,445
	60 x 36 x 7½	1500 x 900 x 191	N_NNN-RS3660C5	1,088	1,384
	Specify the surface type (5, 6).				
Specify the surface type (5, 6).	84 x 36 x 7½	2100 x 900 x 191	N_KNN-RS3684C5	1,854	2,264
	78 x 36 x 7½	1950 x 900 x 191	N_KNN-RS3678C5	1,557	1,942
	72 x 36 x 7½	1800 x 900 x 191	N_KNN-RS3672C5	1,525	1,877
	66 x 36 x 7½	1650 x 900 x 191	N_KNN-RS3666C5	1,490	1,814
	60 x 36 x 7½	1500 x 900 x 191	N_KNN-RS3660C5	1,445	1,738
	Knife edge (K). Specify the surface type (5, 6).				

	W x D x H (in)	W x D x H (mm)	Code	All Laminate (\$)	HPL Surfaces (\$)
Rectangular surfaces, short back, 2 short legs – 30" D	84 x 30 x 7½	2100 x 750 x 191	N_NNN-RS3084C5	1,201	1,557
	78 x 30 x 7½	1950 x 750 x 191	N_NNN-RS3078C5	1,021	1,355
	72 x 30 x 7½	1800 x 750 x 191	N_NNN-RS3072C5	1,008	1,306
	66 x 30 x 7½	1650 x 750 x 191	N_NNN-RS3066C5	984	1,256
	60 x 30 x 7½	1500 x 750 x 191	N_NNN-RS3060C5	960	1,201
	Specify the surface type (1, 2).				
Specify the surface type (1, 2).	84 x 30 x 7½	2100 x 750 x 191	N_NNN-RS3084C5	1,298	1,635
	78 x 30 x 7½	1950 x 750 x 191	N_NNN-RS3078C5	1,114	1,434
	72 x 30 x 7½	1800 x 750 x 191	N_NNN-RS3072C5	1,080	1,379
	66 x 30 x 7½	1650 x 750 x 191	N_NNN-RS3066C5	1,054	1,322
	60 x 30 x 7½	1500 x 750 x 191	N_NNN-RS3060C5	1,015	1,264
	Specify the surface type (5, 6).				
Specify the surface type (5, 6).	84 x 30 x 7½	2100 x 750 x 191	N_KNN-RS3084C5	1,766	2,106
	78 x 30 x 7½	1950 x 750 x 191	N_KNN-RS3078C5	1,482	1,786
	72 x 30 x 7½	1800 x 750 x 191	N_KNN-RS3072C5	1,445	1,738
	66 x 30 x 7½	1650 x 750 x 191	N_KNN-RS3066C5	1,411	1,676
	60 x 30 x 7½	1500 x 750 x 191	N_KNN-RS3060C5	1,379	1,628
	Knife edge (K). Specify the surface type (5, 6).				

	W x D x H (in)	W x D x H (mm)	Code	All Laminate (\$)	HPL Surfaces (\$)
Rectangular surfaces, short back, 2 short legs – 24" D	72 x 24 x 7½	1800 x 600 x 191	N_NNN-RS2472C5	951	1,193
	66 x 24 x 7½	1650 x 600 x 191	N_NNN-RS2466C5	918	1,152
	60 x 24 x 7½	1500 x 600 x 191	N_NNN-RS2460C5	902	1,102
	54 x 24 x 7½	1350 x 600 x 191	N_NNN-RS2454C5	885	1,065
	48 x 24 x 7½	1200 x 600 x 191	N_NNN-RS2448C5	862	1,021
	Specify the surface type (1, 2).				
Specify the surface type (1, 2).	72 x 24 x 7½	1800 x 600 x 191	N_NNN-RS2472C5	1,008	1,242
	66 x 24 x 7½	1650 x 600 x 191	N_NNN-RS2466C5	973	1,193
	60 x 24 x 7½	1500 x 600 x 191	N_NNN-RS2460C5	951	1,152
	54 x 24 x 7½	1350 x 600 x 191	N_NNN-RS2454C5	918	1,096
	48 x 24 x 7½	1200 x 600 x 191	N_NNN-RS2448C5	896	1,054
	Specify the surface type (5, 6).				
Specify the surface type (5, 6).	72 x 24 x 7½	1800 x 600 x 191	N_KNN-RS2472C5	1,371	1,605
	66 x 24 x 7½	1650 x 600 x 191	N_KNN-RS2466C5	1,335	1,557
	60 x 24 x 7½	1500 x 600 x 191	N_KNN-RS2460C5	1,306	1,506
	54 x 24 x 7½	1350 x 600 x 191	N_KNN-RS2454C5	1,282	1,459
	48 x 24 x 7½	1200 x 600 x 191	N_KNN-RS2448C5	1,256	1,411
	Knife edge (K). Specify the surface type (5, 6).				

DESKS WITH MEETING SPACE						
	W x D x H (in)	W x D x H (mm)	Code	All Laminate (\$)	HPL Surfaces (\$)	
Rectangular desks, full modesty panel, 1 long and 1 narrow leg, meeting space – 36" D	78 x 36 x 29½	1950 x 900 x 752	N_N_N-RTM3678	1,176	1,557	
	72 x 36 x 29½	1800 x 900 x 752	N_N_N-RTM3672	1,138	1,499	
	66 x 36 x 29½	1650 x 900 x 752	N_N_N-RTM3666	1,102	1,434	
	60 x 36 x 29½	1500 x 900 x 752	N_N_N-RTM3660	1,071	1,379	
	Specify the surface type (1, 2). Specify left (L) or right (R). Specify the modesty panel finish (B, W, N).					
	Specify the surface type (1, 2). Specify left (L) or right (R). Specify the modesty panel finish (B, W, N).	78 x 36 x 29½	1950 x 900 x 752	N_N_N-RTM3678	1,317	1,709
72 x 36 x 29½		1800 x 900 x 752	N_N_N-RTM3672	1,274	1,628	
66 x 36 x 29½		1650 x 900 x 752	N_N_N-RTM3666	1,225	1,546	
60 x 36 x 29½		1500 x 900 x 752	N_N_N-RTM3660	1,182	1,482	
Specify the surface type (5, 6). Specify left (L) or right (R). Specify the modesty panel finish (B, W, N).						
Specify the surface type (5, 6). Specify left (L) or right (R). Specify the modesty panel finish (B, W, N).		78 x 36 x 29½	1950 x 900 x 752	N_K_N-RTM3678	1,983	2,371
	72 x 36 x 29½	1800 x 900 x 752	N_K_N-RTM3672	1,910	2,257	
	66 x 36 x 29½	1650 x 900 x 752	N_K_N-RTM3666	1,829	2,150	
	60 x 36 x 29½	1500 x 900 x 752	N_K_N-RTM3660	1,749	2,047	
	Knife edge (K). Specify the surface type (5, 6). Specify left (L) or right (R). Specify the modesty panel finish (B, W, N).					

High-Gloss Black (B) or High-Gloss White (W) modesty panel finish option: add \$323.

W x D x H (in)	W x D x H (mm)	Code	All Laminate (\$)	HPL Surfaces (\$)
Rectangular desks, full modesty panel, 1 long and 1 narrow leg, meeting space – 30" D				
<i>6" (150 mm) recessed full-height modesty panel. Meeting space. 1 grommet. Must be secured to another surface. Can accommodate 1 pedestal NNN_-161820F or NNN_-MP161820F.</i>				
78 x 30 x 29½	1950 x 750 x 752	N_N_-RTM3078	1,114	1,426
72 x 30 x 29½	1800 x 750 x 752	N_N_-RTM3072	1,080	1,379
66 x 30 x 29½	1650 x 750 x 752	N_N_-RTM3066	1,047	1,322
60 x 30 x 29½	1500 x 750 x 752	N_N_-RTM3060	1,015	1,274
Specify the surface type (1, 2). Specify left (L) or right (R). Specify the modesty panel finish (B, W, N).				
78 x 30 x 29½	1950 x 750 x 752	N_N_-RTM3078	1,219	1,538
72 x 30 x 29½	1800 x 750 x 752	N_N_-RTM3072	1,182	1,482
66 x 30 x 29½	1650 x 750 x 752	N_N_-RTM3066	1,152	1,419
60 x 30 x 29½	1500 x 750 x 752	N_N_-RTM3060	1,102	1,345
Specify the surface type (5, 6). Specify left (L) or right (R). Specify the modesty panel finish (B, W, N).				
78 x 30 x 29½	1950 x 750 x 752	N_K_-RTM3078	1,882	2,217
72 x 30 x 29½	1800 x 750 x 752	N_K_-RTM3072	1,821	2,111
66 x 30 x 29½	1650 x 750 x 752	N_K_-RTM3066	1,749	2,022
60 x 30 x 29½	1500 x 750 x 752	N_K_-RTM3060	1,676	1,926
Knife edge (K). Specify the surface type (5, 6). Specify left (L) or right (R). Specify the modesty panel finish (B, W, N).				

W x D x H (in)	W x D x H (mm)	Code	All Laminate (\$)	HPL Surfaces (\$)
Rectangular desks, short back, 1 long and 1 slim metal leg, meeting space – 36" D				
<i>9" (225 mm) recessed short back. Meeting space. 1 grommet. 1 slim metal leg. Can accommodate 1 storage module and 1 modular modesty panel. Must be secured to another surface.</i>				
78 x 36 x 29½	1950 x 900 x 752	N_N_N-RT3678PA5	1,950	2,329
72 x 36 x 29½	1800 x 900 x 752	N_N_N-RT3672PA5	1,918	2,281
66 x 36 x 29½	1650 x 900 x 752	N_N_N-RT3666PA5	1,882	2,217
60 x 36 x 29½	1500 x 900 x 752	N_N_N-RT3660PA5	1,863	2,161
Specify the surface type (1, 2). Specify left (L) or right (R).				
78 x 36 x 29½	1950 x 900 x 752	N_N_N-RT3678PA5	2,062	2,442
72 x 36 x 29½	1800 x 900 x 752	N_N_N-RT3672PA5	2,029	2,376
66 x 36 x 29½	1650 x 900 x 752	N_N_N-RT3666PA5	1,983	2,314
60 x 36 x 29½	1500 x 900 x 752	N_N_N-RT3660PA5	1,950	2,247
Specify the surface type (5, 6). Specify left (L) or right (R).				
78 x 36 x 29½	1950 x 900 x 752	N_K_N-RT3678PA5	2,344	2,732
72 x 36 x 29½	1800 x 900 x 752	N_K_N-RT3672PA5	2,305	2,662
66 x 36 x 29½	1650 x 900 x 752	N_K_N-RT3666PA5	2,271	2,594
60 x 36 x 29½	1500 x 900 x 752	N_K_N-RT3660PA5	2,224	2,523
Knife edge (K). Specify the surface type (5, 6). Specify left (L) or right (R).				

W x D x H (in)	W x D x H (mm)	Code	All Laminate (\$)	HPL Surfaces (\$)
Rectangular desks, short back, 1 long and 1 slim metal leg, meeting space – 30" D				
<i>6" (150 mm) recessed short back. Meeting space. 1 grommet. 1 slim metal leg. Can accommodate 1 storage module and 1 modular modesty panel. Must be secured to another surface.</i>				
78 x 30 x 29½	1950 x 750 x 752	N_N_N-RT3078PA5	1,877	2,199
72 x 30 x 29½	1800 x 750 x 752	N_N_N-RT3072PA5	1,854	2,150
66 x 30 x 29½	1650 x 750 x 752	N_N_N-RT3066PA5	1,829	2,095
60 x 30 x 29½	1500 x 750 x 752	N_N_N-RT3060PA5	1,806	2,047
Specify the surface type (1, 2). Specify left (L) or right (R).				
78 x 30 x 29½	1950 x 750 x 752	N_N_N-RT3078PA5	1,967	2,296
72 x 30 x 29½	1800 x 750 x 752	N_N_N-RT3072PA5	1,942	2,241
66 x 30 x 29½	1650 x 750 x 752	N_N_N-RT3066PA5	1,910	2,184
60 x 30 x 29½	1500 x 750 x 752	N_N_N-RT3060PA5	1,869	2,135
Specify the surface type (5, 6). Specify left (L) or right (R).				
78 x 30 x 29½	1950 x 750 x 752	N_K_N-RT3078PA5	2,257	2,577
72 x 30 x 29½	1800 x 750 x 752	N_K_N-RT3072PA5	2,217	2,523
66 x 30 x 29½	1650 x 750 x 752	N_K_N-RT3066PA5	2,184	2,474
60 x 30 x 29½	1500 x 750 x 752	N_K_N-RT3060PA5	2,161	2,418
Knife edge (K). Specify the surface type (5, 6). Specify left (L) or right (R).				

W x D x H (in)	W x D x H (mm)	Code	All Laminate (\$)	HPL Surfaces (\$)
Rectangular desks, short back, 1 long and 1 slim metal leg, meeting space – 24" D				
<i>3" (75 mm) recessed short back. Meeting space. 1 grommet. 1 slim metal leg. Must be secured to another surface. Can accommodate 1 modular modesty panel.</i>				
78 x 24 x 29½	1950 x 600 x 752	N_N_N-RT2478PA5	1,806	2,062
72 x 24 x 29½	1800 x 600 x 752	N_N_N-RT2472PA5	1,780	2,022
66 x 24 x 29½	1650 x 600 x 752	N_N_N-RT2466PA5	1,760	1,983
60 x 24 x 29½	1500 x 600 x 752	N_N_N-RT2460PA5	1,738	1,942
Specify the surface type (1, 2). Specify left (L) or right (R).				
78 x 24 x 29½	1950 x 600 x 752	N_N_N-RT2478PA5	1,869	2,135
72 x 24 x 29½	1800 x 600 x 752	N_N_N-RT2472PA5	1,847	2,081
66 x 24 x 29½	1650 x 600 x 752	N_N_N-RT2466PA5	1,821	2,038
60 x 24 x 29½	1500 x 600 x 752	N_N_N-RT2460PA5	1,786	1,988
Specify the surface type (5, 6). Specify left (L) or right (R).				
78 x 24 x 29½	1950 x 600 x 752	N_K_N-RT2478PA5	2,161	2,410
72 x 24 x 29½	1800 x 600 x 752	N_K_N-RT2472PA5	2,135	2,371
66 x 24 x 29½	1650 x 600 x 752	N_K_N-RT2466PA5	2,106	2,322
60 x 24 x 29½	1500 x 600 x 752	N_K_N-RT2460PA5	2,081	2,271
Knife edge (K). Specify the surface type (5, 6). Specify left (L) or right (R).				

WORK SURFACES WITH MEETING SPACE				
Rectangular surfaces, short back, 1 short and 1 slim metal leg, meeting space – 36" D				
<i>9" (225 mm) recessed short back. Meeting space. 1 grommet. 1 slim metal leg. Must use 1 storage module 21" H (561 mm) as support. Can accommodate 1 modular modesty panel.</i>				
84 x 36 x 29½	2100 x 900 x 752	N_N_N-RS3684PB5	2,001	2,418
78 x 36 x 29½	1950 x 900 x 752	N_N_N-RS3678PB5	1,829	2,217
72 x 36 x 29½	1800 x 900 x 752	N_N_N-RS3672PB5	1,806	2,161
66 x 36 x 29½	1650 x 900 x 752	N_N_N-RS3666PB5	1,766	2,095
60 x 36 x 29½	1500 x 900 x 752	N_N_N-RS3660PB5	1,738	2,047
Specify the surface type (1, 2). Specify left (L) or right (R).				
84 x 36 x 29½	2100 x 900 x 752	N_N_N-RS3684PB5	2,144	2,539
78 x 36 x 29½	1950 x 900 x 752	N_N_N-RS3678PB5	1,950	2,329
72 x 36 x 29½	1800 x 900 x 752	N_N_N-RS3672PB5	1,918	2,264
66 x 36 x 29½	1650 x 900 x 752	N_N_N-RS3666PB5	1,869	2,191
60 x 36 x 29½	1500 x 900 x 752	N_N_N-RS3660PB5	1,838	2,129
Specify the surface type (5, 6). Specify left (L) or right (R).				
84 x 36 x 29½	2100 x 900 x 752	N_K_N-RS3684PB5	2,531	2,934
78 x 36 x 29½	1950 x 900 x 752	N_K_N-RS3678PB5	2,241	2,614
72 x 36 x 29½	1800 x 900 x 752	N_K_N-RS3672PB5	2,191	2,539
66 x 36 x 29½	1650 x 900 x 752	N_K_N-RS3666PB5	2,161	2,481
60 x 36 x 29½	1500 x 900 x 752	N_K_N-RS3660PB5	2,111	2,410
Knife edge (K). Specify the surface type (5, 6). Specify left (L) or right (R).				

W x D x H (in)	W x D x H (mm)	Code	All Laminate (\$)	HPL Surfaces (\$)
Rectangular surfaces, short back, 1 short and 1 slim metal leg, meeting space – 30" D				
<i>6" (150 mm) recessed short back. Meeting space. 1 grommet. 1 slim metal leg. Must use 1 storage module 21" H (561 mm) as support. Can accommodate 1 modular modesty panel.</i>				
84 x 30 x 29½	2100 x 750 x 752	N_N_N-RS3084PB5	1,950	2,296
78 x 30 x 29½	1950 x 750 x 752	N_N_N-RS3078PB5	1,772	2,106
72 x 30 x 29½	1800 x 750 x 752	N_N_N-RS3072PB5	1,749	2,057
66 x 30 x 29½	1650 x 750 x 752	N_N_N-RS3066PB5	1,725	2,001
60 x 30 x 29½	1500 x 750 x 752	N_N_N-RS3060PB5	1,702	1,950
Specify the surface type (1, 2). Specify left (L) or right (R).				
84 x 30 x 29½	2100 x 750 x 752	N_N_N-RS3084PB5	2,087	2,393
78 x 30 x 29½	1950 x 750 x 752	N_N_N-RS3078PB5	1,892	2,191
72 x 30 x 29½	1800 x 750 x 752	N_N_N-RS3072PB5	1,854	2,135
66 x 30 x 29½	1650 x 750 x 752	N_N_N-RS3066PB5	1,814	2,081
60 x 30 x 29½	1500 x 750 x 752	N_N_N-RS3060PB5	1,772	2,022
Specify the surface type (5, 6). Specify left (L) or right (R).				
84 x 30 x 29½	2100 x 750 x 752	N_K_N-RS3084PB5	2,481	2,787
78 x 30 x 29½	1950 x 750 x 752	N_K_N-RS3078PB5	2,184	2,474
72 x 30 x 29½	1800 x 750 x 752	N_K_N-RS3072PB5	2,144	2,418
66 x 30 x 29½	1650 x 750 x 752	N_K_N-RS3066PB5	2,095	2,362
60 x 30 x 29½	1500 x 750 x 752	N_K_N-RS3060PB5	2,057	2,296
Knife edge (K). Specify the surface type (5, 6). Specify left (L) or right (R).				

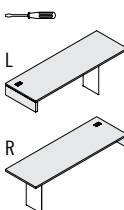
	W x D x H (in)	W x D x H (mm)	Code	All Laminate (\$)	HPL Surfaces (\$)
Rectangular surfaces, short back, 1 short and 1 slim metal leg, meeting space – 24" D 	<i>3" (75 mm) recessed short back. Meeting space. 1 grommet. 1 slim metal leg. Must use 1 storage module 21" H (561 mm) as support. Can accommodate 1 modular modesty panel.</i>				
	78 x 24 x 29½	1950 x 600 x 752	N_N_N-RS2478PB5	1,725	1,983
	72 x 24 x 29½	1800 x 600 x 752	N_N_N-RS2472PB5	1,702	1,942
	66 x 24 x 29½	1650 x 600 x 752	N_N_N-RS2466PB5	1,676	1,892
	60 x 24 x 29½	1500 x 600 x 752	N_N_N-RS2460PB5	1,654	1,854
	Specify the surface type (1, 2). Specify left (L) or right (R).				
	78 x 24 x 29½	1950 x 600 x 752	N_N_N-RS2478PB5	1,786	2,047
	72 x 24 x 29½	1800 x 600 x 752	N_N_N-RS2472PB5	1,766	2,001
	66 x 24 x 29½	1650 x 600 x 752	N_N_N-RS2466PB5	1,738	1,959
	60 x 24 x 29½	1500 x 600 x 752	N_N_N-RS2460PB5	1,716	1,910
	Specify the surface type (5, 6). Specify left (L) or right (R).				
	78 x 24 x 29½	1950 x 600 x 752	N_K_N-RS2478PB5	2,071	2,329
	72 x 24 x 29½	1800 x 600 x 752	N_K_N-RS2472PB5	2,047	2,281
	66 x 24 x 29½	1650 x 600 x 752	N_K_N-RS2466PB5	2,022	2,241
	60 x 24 x 29½	1500 x 600 x 752	N_K_N-RS2460PB5	1,988	2,191
	Knife edge (K). Specify the surface type (5, 6). Specify left (L) or right (R).				

COLLABORATIVE SURFACES

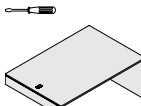
	W x D x H (in)	W x D x H (mm)	Code	All Laminate (\$)	HPL Surfaces (\$)
Collaborative surfaces, short backs, 1 long and 1 short leg – 48" D 	<i>Double short backs centered on the surface. 1 grommet. Must use 1 storage module 21" H (561 mm) as support.</i>				
	84 x 48 x 29½	2100 x 1200 x 752	N_NNN-CS4884B5	1,568	1,998
	78 x 48 x 29½	1950 x 1200 x 752	N_NNN-CS4878B5	1,490	1,891
	72 x 48 x 29½	1800 x 1200 x 752	N_NNN-CS4872B5	1,411	1,792
	66 x 48 x 29½	1650 x 1200 x 752	N_NNN-CS4866B5	1,331	1,683
	60 x 48 x 29½	1500 x 1200 x 752	N_NNN-CS4860B5	1,259	1,576
	Specify the surface type (1, 2).				
	84 x 48 x 29½	2100 x 1200 x 752	N_NNN-CS4884B5	1,756	2,198
	78 x 48 x 29½	1950 x 1200 x 752	N_NNN-CS4878B5	1,669	1,980
	72 x 48 x 29½	1800 x 1200 x 752	N_NNN-CS4872B5	1,576	1,961
	66 x 48 x 29½	1650 x 1200 x 752	N_NNN-CS4866B5	1,490	1,841
	60 x 48 x 29½	1500 x 1200 x 752	N_NNN-CS4860B5	1,396	1,717
	Specify the surface type (5, 6).				
	84 x 48 x 29½	2100 x 1200 x 752	N_KNN-CS4884B5	2,278	2,742
	78 x 48 x 29½	1950 x 1200 x 752	N_KNN-CS4878B5	2,162	2,593
	72 x 48 x 29½	1800 x 1200 x 752	N_KNN-CS4872B5	2,040	2,441
	66 x 48 x 29½	1650 x 1200 x 752	N_KNN-CS4866B5	1,926	2,292
	60 x 48 x 29½	1500 x 1200 x 752	N_KNN-CS4860B5	1,812	2,142
	Knife edge (K). Specify the surface type (5, 6).				

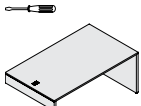
	W x D x H (in)	W x D x H (mm)	Code	All Laminate (\$)	HPL Surfaces (\$)
Collaborative surfaces, short backs, 1 long and 1 short leg – 42" D 	<i>Double short backs centered on the surface. 1 grommet. Must use 1 storage module 21" H (561 mm) as support.</i>				
	84 x 42 x 29½	2100 x 1050 x 752	N_NNN-CS4284B5	1,402	1,783
	78 x 42 x 29½	1950 x 1050 x 752	N_NNN-CS4278B5	1,354	1,706
	72 x 42 x 29½	1800 x 1050 x 752	N_NNN-CS4272B5	1,296	1,633
	66 x 42 x 29½	1650 x 1050 x 752	N_NNN-CS4266B5	1,247	1,555
	60 x 42 x 29½	1500 x 1050 x 752	N_NNN-CS4260B5	1,196	1,475
	Specify the surface type (1, 2).				
	84 x 42 x 29½	2100 x 1050 x 752	N_NNN-CS4284B5	1,576	1,961
	78 x 42 x 29½	1950 x 1050 x 752	N_NNN-CS4278B5	1,511	1,869
	72 x 42 x 29½	1800 x 1050 x 752	N_NNN-CS4272B5	1,447	1,783
	66 x 42 x 29½	1650 x 1050 x 752	N_NNN-CS4266B5	1,382	1,689
	60 x 42 x 29½	1500 x 1050 x 752	N_NNN-CS4260B5	1,319	1,604
	Specify the surface type (5, 6).				
	84 x 42 x 29½	2100 x 1050 x 752	N_KNN-CS4284B5	2,112	2,536
	78 x 42 x 29½	1950 x 1050 x 752	N_KNN-CS4278B5	2,026	2,422
	72 x 42 x 29½	1800 x 1050 x 752	N_KNN-CS4272B5	1,942	2,305
	66 x 42 x 29½	1650 x 1050 x 752	N_KNN-CS4266B5	1,854	2,191
	60 x 42 x 29½	1500 x 1050 x 752	N_KNN-CS4260B5	1,768	2,078
	Knife edge (K). Specify the surface type (5, 6).				

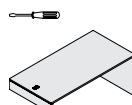
	W x D x H (in)	W x D x H (mm)	Code	All Laminate (\$)	HPL Surfaces (\$)
Collaborative surfaces, short backs, 1 long and 1 short leg – 36" D 	<i>Double short backs centered on the surface. 1 grommet. Must use 1 storage module 21" H (561 mm) as support.</i>				
	84 x 36 x 29½	2100 x 900 x 752	N_NNN-CS3684B5	1,239	1,568
	78 x 36 x 29½	1950 x 900 x 752	N_NNN-CS3678B5	1,219	1,526
	72 x 36 x 29½	1800 x 900 x 752	N_NNN-CS3672B5	1,189	1,475
	66 x 36 x 29½	1650 x 900 x 752	N_NNN-CS3666B5	1,160	1,426
	60 x 36 x 29½	1500 x 900 x 752	N_NNN-CS3660B5	1,132	1,375
	Specify the surface type (1, 2).				
	84 x 36 x 29½	2100 x 900 x 752	N_NNN-CS3684B5	1,390	1,726
	78 x 36 x 29½	1950 x 900 x 752	N_NNN-CS3678B5	1,354	1,669
	72 x 36 x 29½	1800 x 900 x 752	N_NNN-CS3672B5	1,319	1,604
	66 x 36 x 29½	1650 x 900 x 752	N_NNN-CS3666B5	1,275	1,546
	60 x 36 x 29½	1500 x 900 x 752	N_NNN-CS3660B5	1,239	1,490
	Specify the surface type (5, 6).				
	84 x 36 x 29½	2100 x 900 x 752	N_KNN-CS3684B5	1,949	2,328
	78 x 36 x 29½	1950 x 900 x 752	N_KNN-CS3678B5	1,891	2,241
	72 x 36 x 29½	1800 x 900 x 752	N_KNN-CS3672B5	1,841	2,162
	66 x 36 x 29½	1650 x 900 x 752	N_KNN-CS3666B5	1,792	2,084
	60 x 36 x 29½	1500 x 900 x 752	N_KNN-CS3660B5	1,733	2,005
	Knife edge (K). Specify the surface type (5, 6).				

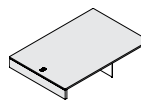
	W x D x H (in)	W x D x H (mm)	Code	All Laminate (\$)	HPL Surfaces (\$)
Collaborative surfaces, short backs, 1 short and 1 slim metal leg, meeting space – 48" D 	<i>Double short backs centered on the surface. Meeting space. 1 grommet. 1 slim metal leg. Must use 1 storage module 21" H (561 mm) as support.</i>				
	84 x 48 x 29½	2100 x 1200 x 752	N_NNN-CS4884PB5	2,305	2,801
	78 x 48 x 29½	1950 x 1200 x 752	N_NNN-CS4878PB5	2,241	2,706
	72 x 48 x 29½	1800 x 1200 x 752	N_NNN-CS4872PB5	2,168	2,607
	66 x 48 x 29½	1650 x 1200 x 752	N_NNN-CS4866PB5	2,107	2,514
	60 x 48 x 29½	1500 x 1200 x 752	N_NNN-CS4860PB5	2,035	2,413
	Specify the surface type (1, 2).				
	84 x 48 x 29½	2100 x 1200 x 752	N_NNN-CS4884PB5	2,493	2,994
	78 x 48 x 29½	1950 x 1200 x 752	N_NNN-CS4878PB5	2,404	2,885
	72 x 48 x 29½	1800 x 1200 x 752	N_NNN-CS4872PB5	2,328	2,773
	66 x 48 x 29½	1650 x 1200 x 752	N_NNN-CS4866PB5	2,247	2,666
	60 x 48 x 29½	1500 x 1200 x 752	N_NNN-CS4860PB5	2,168	2,557
	Specify the surface type (5, 6).				
	84 x 48 x 29½	2100 x 1200 x 752	N_KNN-CS4884PB5	2,828	3,350
	78 x 48 x 29½	1950 x 1200 x 752	N_KNN-CS4878PB5	2,735	3,230
	72 x 48 x 29½	1800 x 1200 x 752	N_KNN-CS4872PB5	2,650	3,106
	66 x 48 x 29½	1650 x 1200 x 752	N_KNN-CS4866PB5	2,557	2,987
	60 x 48 x 29½	1500 x 1200 x 752	N_KNN-CS4860PB5	2,464	2,858
	Knife edge (K). Specify the surface type (5, 6).				

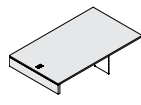
	W x D x H (in)	W x D x H (mm)	Code	All Laminate (\$)	HPL Surfaces (\$)
Collaborative surfaces, short backs, 1 short and 1 slim metal leg, meeting space – 42" D 	<i>Double short backs centered on the surface. Meeting space. 1 grommet. 1 slim metal leg. Must use 1 storage module 21" H (561 mm) as support.</i>				
	84 x 42 x 29½	2100 x 1050 x 752	N_NNN-CS4284PB5	2,179	2,621
	78 x 42 x 29½	1950 x 1050 x 752	N_NNN-CS4278PB5	2,134	2,548
	72 x 42 x 29½	1800 x 1050 x 752	N_NNN-CS4272PB5	2,084	2,477
	66 x 42 x 29½	1650 x 1050 x 752	N_NNN-CS4266PB5	2,035	2,404
	60 x 42 x 29½	1500 x 1050 x 752	N_NNN-CS4260PB5	1,990	2,335
	Specify the surface type (1, 2).				
	84 x 42 x 29½	2100 x 1050 x 752	N_NNN-CS4284PB5	2,341	2,792
	78 x 42 x 29½	1950 x 1050 x 752	N_NNN-CS4278PB5	2,278	2,706
	72 x 42 x 29½	1800 x 1050 x 752	N_NNN-CS4272PB5	2,220	2,621
	66 x 42 x 29½	1650 x 1050 x 752	N_NNN-CS4266PB5	2,162	2,542
	60 x 42 x 29½	1500 x 1050 x 752	N_NNN-CS4260PB5	2,107	2,456
	Specify the surface type (5, 6).				
	84 x 42 x 29½	2100 x 1050 x 752	N_KNN-CS4284PB5	2,656	3,123
	78 x 42 x 29½	1950 x 1050 x 752	N_KNN-CS4278PB5	2,593	3,028
	72 x 42 x 29½	1800 x 1050 x 752	N_KNN-CS4272PB5	2,529	2,936
	66 x 42 x 29½	1650 x 1050 x 752	N_KNN-CS4266PB5	2,456	2,844
	60 x 42 x 29½	1500 x 1050 x 752	N_KNN-CS4260PB5	2,391	2,751
	Knife edge (K). Specify the surface type (5, 6).				

Collaborative surfaces, short backs, 1 short and 1 slim metal leg, meeting space – 36" D

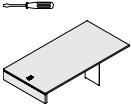

W x D x H (in)	W x D x H (mm)	Code	All Laminate (\$)	HPL Surfaces (\$)
<i>Double short backs centered on the surface. Meeting space. 1 grommet. 1 slim metal leg. Must use 1 storage module 21" H (561 mm) as support.</i>				
84 x 36 x 29½	2100 x 900 x 752	N_NNN-CS3684PB5	2,048	2,436
78 x 36 x 29½	1950 x 900 x 752	N_NNN-CS3678PB5	2,020	2,391
72 x 36 x 29½	1800 x 900 x 752	N_NNN-CS3672PB5	1,998	2,341
66 x 36 x 29½	1650 x 900 x 752	N_NNN-CS3666PB5	1,969	2,298
60 x 36 x 29½	1500 x 900 x 752	N_NNN-CS3660PB5	1,942	2,247
Specify the surface type (1, 2).				
84 x 36 x 29½	2100 x 900 x 752	N_NNN-CS3684PB5	2,185	2,585
78 x 36 x 29½	1950 x 900 x 752	N_NNN-CS3678PB5	2,148	2,529
72 x 36 x 29½	1800 x 900 x 752	N_NNN-CS3672PB5	2,112	2,470
66 x 36 x 29½	1650 x 900 x 752	N_NNN-CS3666PB5	2,078	2,413
60 x 36 x 29½	1500 x 900 x 752	N_NNN-CS3660PB5	2,040	2,356
Specify the surface type (5, 6).				
84 x 36 x 29½	2100 x 900 x 752	N_KNN-CS3684PB5	2,529	2,958
78 x 36 x 29½	1950 x 900 x 752	N_KNN-CS3678PB5	2,485	2,894
72 x 36 x 29½	1800 x 900 x 752	N_KNN-CS3672PB5	2,448	2,828
66 x 36 x 29½	1650 x 900 x 752	N_KNN-CS3666PB5	2,404	2,764
60 x 36 x 29½	1500 x 900 x 752	N_KNN-CS3660PB5	2,364	2,701

Knife edge (K). Specify the surface type (5, 6).

WORK SURFACES WITH STRUT(S)

Rectangular surfaces, 2 struts – 36" D

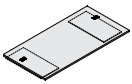

W x D x H (in)	W x D x H (mm)	Code	All Laminate (\$)	HPL Surfaces (\$)
<i>Surface with struts. 2 grommets. Must use storage modules 27" H (690 mm) as support. Can accommodate 1 modular modesty panel.</i>				
84 x 36 x 2½	2100 x 900 x 63,5	N_NNN-RS3684D6	874	1,175
78 x 36 x 2½	1950 x 900 x 63,5	N_NNN-RS3678D6	846	1,132
72 x 36 x 2½	1800 x 900 x 63,5	N_NNN-RS3672D6	824	1,081
66 x 36 x 2½	1650 x 900 x 63,5	N_NNN-RS3666D6	803	1,040
60 x 36 x 2½	1500 x 900 x 63,5	N_NNN-RS3660D6	773	995
Specify the surface type (1, 2).				
84 x 36 x 2½	2100 x 900 x 63,5	N_NNN-RS3684D6	1,022	1,331
78 x 36 x 2½	1950 x 900 x 63,5	N_NNN-RS3678D6	995	1,275
72 x 36 x 2½	1800 x 900 x 63,5	N_NNN-RS3672D6	960	1,219
66 x 36 x 2½	1650 x 900 x 63,5	N_NNN-RS3666D6	924	1,168
60 x 36 x 2½	1500 x 900 x 63,5	N_NNN-RS3660D6	888	1,111
Specify the surface type (5, 6).				
84 x 36 x 2½	2100 x 900 x 63,5	N_KNN-RS3684D6	1,202	1,511
78 x 36 x 2½	1950 x 900 x 63,5	N_KNN-RS3678D6	1,168	1,453
72 x 36 x 2½	1800 x 900 x 63,5	N_KNN-RS3672D6	1,140	1,402
66 x 36 x 2½	1650 x 900 x 63,5	N_KNN-RS3666D6	1,102	1,346
60 x 36 x 2½	1500 x 900 x 63,5	N_KNN-RS3660D6	1,067	1,296

Knife edge (K). Specify the surface type (5, 6).

Rectangular surfaces, 2 struts – 30" D

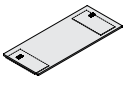

W x D x H (in)	W x D x H (mm)	Code	All Laminate (\$)	HPL Surfaces (\$)
<i>Surface with struts. 2 grommets. Must use storage modules 27" H (690 mm) as support. Can accommodate 1 modular modesty panel.</i>				
84 x 30 x 2½	2100 x 750 x 63,5	N_NNN-RS3084D6	824	1,102
78 x 30 x 2½	1950 x 750 x 63,5	N_NNN-RS3078D6	803	1,060
72 x 30 x 2½	1800 x 750 x 63,5	N_NNN-RS3072D6	773	1,016
66 x 30 x 2½	1650 x 750 x 63,5	N_NNN-RS3066D6	753	972
60 x 30 x 2½	1500 x 750 x 63,5	N_NNN-RS3060D6	730	933
Specify the surface type (1, 2).				
84 x 30 x 2½	2100 x 750 x 63,5	N_NNN-RS3084D6	960	1,219
78 x 30 x 2½	1950 x 750 x 63,5	N_NNN-RS3078D6	924	1,168
72 x 30 x 2½	1800 x 750 x 63,5	N_NNN-RS3072D6	888	1,111
66 x 30 x 2½	1650 x 750 x 63,5	N_NNN-RS3066D6	860	1,060
60 x 30 x 2½	1500 x 750 x 63,5	N_NNN-RS3060D6	824	1,010
Specify the surface type (5, 6).				
84 x 30 x 2½	2100 x 750 x 63,5	N_KNN-RS3084D6	1,117	1,375
78 x 30 x 2½	1950 x 750 x 63,5	N_KNN-RS3078D6	1,089	1,331
72 x 30 x 2½	1800 x 750 x 63,5	N_KNN-RS3072D6	1,060	1,282
66 x 30 x 2½	1650 x 750 x 63,5	N_KNN-RS3066D6	1,022	1,231
60 x 30 x 2½	1500 x 750 x 63,5	N_KNN-RS3060D6	995	1,180

Knife edge (K). Specify the surface type (5, 6).

Rectangular surfaces, 2 struts – 24" D

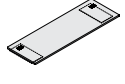

W x D x H (in)	W x D x H (mm)	Code	All Laminate (\$)	HPL Surfaces (\$)
<i>Surface with struts. 2 grommets. Must use storage modules 27" H (690 mm) as support. Can accommodate 1 modular modesty panel.</i>				
72 x 24 x 2½	1800 x 600 x 63,5	N_NNN-RS2472D6	730	953
66 x 24 x 2½	1650 x 600 x 63,5	N_NNN-RS2466D6	710	910
60 x 24 x 2½	1500 x 600 x 63,5	N_NNN-RS2460D6	687	874
54 x 24 x 2½	1350 x 600 x 63,5	N_NNN-RS2454D6	666	831
48 x 24 x 2½	1200 x 600 x 63,5	N_NNN-RS2448D6	645	796
Specify the surface type (1, 2).				
72 x 24 x 2½	1800 x 600 x 63,5	N_NNN-RS2472D6	824	1,010
66 x 24 x 2½	1650 x 600 x 63,5	N_NNN-RS2466D6	796	960
60 x 24 x 2½	1500 x 600 x 63,5	N_NNN-RS2460D6	766	916
54 x 24 x 2½	1350 x 600 x 63,5	N_NNN-RS2454D6	737	865
48 x 24 x 2½	1200 x 600 x 63,5	N_NNN-RS2448D6	702	824
Specify the surface type (5, 6).				
72 x 24 x 2½	1800 x 600 x 63,5	N_KNN-RS2472D6	982	1,168
66 x 24 x 2½	1650 x 600 x 63,5	N_KNN-RS2466D6	953	1,124
60 x 24 x 2½	1500 x 600 x 63,5	N_KNN-RS2460D6	924	1,081
54 x 24 x 2½	1350 x 600 x 63,5	N_KNN-RS2454D6	896	1,033
48 x 24 x 2½	1200 x 600 x 63,5	N_KNN-RS2448D6	865	989

Knife edge (K). Specify the surface type (5, 6).

Rectangular surfaces, 1 strut, 1 slim metal leg – 48" D

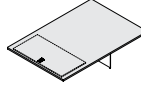

W x D x H (in)	W x D x H (mm)	Code	All Laminate (\$)	HPL Surfaces (\$)
<i>Surface with strut. Meeting space. 1 grommet. 1 slim metal leg. Must use storage module 27" H (690 mm) as support. Can accommodate 1 modular modesty panel.</i>				
84 x 48 x 29½	2100 x 1200 x 752	N_NNN-RS4884PD6	2,213	2,656
78 x 48 x 29½	1950 x 1200 x 752	N_NNN-RS4878PD6	2,185	2,607
72 x 48 x 29½	1800 x 1200 x 752	N_NNN-RS4872PD6	2,156	2,548
66 x 48 x 29½	1650 x 1200 x 752	N_NNN-RS4866PD6	2,129	2,498
60 x 48 x 29½	1500 x 1200 x 752	N_NNN-RS4860PD6	2,097	2,441
Specify the surface type (1, 2).				
84 x 48 x 29½	2100 x 1200 x 752	N_NNN-RS4884PD6	2,427	2,871
78 x 48 x 29½	1950 x 1200 x 752	N_NNN-RS4878PD6	2,386	2,808
72 x 48 x 29½	1800 x 1200 x 752	N_NNN-RS4872PD6	2,341	2,735
66 x 48 x 29½	1650 x 1200 x 752	N_NNN-RS4866PD6	2,298	2,671
60 x 48 x 29½	1500 x 1200 x 752	N_NNN-RS4860PD6	2,256	2,598
Specify the surface type (5, 6).				
84 x 48 x 29½	2100 x 1200 x 752	N_KNN-RS4884PD6	2,464	2,908
78 x 48 x 29½	1950 x 1200 x 752	N_KNN-RS4878PD6	2,427	2,851
72 x 48 x 29½	1800 x 1200 x 752	N_KNN-RS4872PD6	2,391	2,785
66 x 48 x 29½	1650 x 1200 x 752	N_KNN-RS4866PD6	2,349	2,727
60 x 48 x 29½	1500 x 1200 x 752	N_KNN-RS4860PD6	2,314	2,666

Knife edge (K). Specify the surface type (5, 6).

Rectangular surfaces, 1 strut, 1 slim metal leg – 42" D

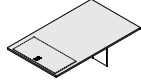

W x D x H (in)	W x D x H (mm)	Code	All Laminate (\$)	HPL Surfaces (\$)
<i>Surface with strut. Meeting space. 1 grommet. 1 slim metal leg. Must use storage module 27" H (690 mm) as support. Can accommodate 1 modular modesty panel.</i>				
84 x 42 x 29½	2100 x 1050 x 752	N_NNN-RS4284PD6	2,090	2,477
78 x 42 x 29½	1950 x 1050 x 752	N_NNN-RS4278PD6	2,061	2,427
72 x 42 x 29½	1800 x 1050 x 752	N_NNN-RS4272PD6	2,035	2,376
66 x 42 x 29½	1650 x 1050 x 752	N_NNN-RS4266PD6	2,005	2,328
60 x 42 x 29½	1500 x 1050 x 752	N_NNN-RS4260PD6	1,977	2,278
Specify the surface type (1, 2).				
84 x 42 x 29½	2100 x 1050 x 752	N_NNN-RS4284PD6	2,278	2,671
78 x 42 x 29½	1950 x 1050 x 752	N_NNN-RS4278PD6	2,235	2,607
72 x 42 x 29½	1800 x 1050 x 752	N_NNN-RS4272PD6	2,198	2,542
66 x 42 x 29½	1650 x 1050 x 752	N_NNN-RS4266PD6	2,156	2,477
60 x 42 x 29½	1500 x 1050 x 752	N_NNN-RS4260PD6	2,118	2,413
Specify the surface type (5, 6).				
84 x 42 x 29½	2100 x 1050 x 752	N_KNN-RS4284PD6	2,386	2,778
78 x 42 x 29½	1950 x 1050 x 752	N_KNN-RS4278PD6	2,349	2,721
72 x 42 x 29½	1800 x 1050 x 752	N_KNN-RS4272PD6	2,314	2,666
66 x 42 x 29½	1650 x 1050 x 752	N_KNN-RS4266PD6	2,278	2,607
60 x 42 x 29½	1500 x 1050 x 752	N_KNN-RS4260PD6	2,241	2,542

Knife edge (K). Specify the surface type (5, 6).

W x D x H (in)	W x D x H (mm)	Code	All Laminate (\$)	HPL Surfaces (\$)
Rectangular surfaces, 1 strut, 1 slim metal leg – 36" D				
<i>Surface with strut. Meeting space. 1 grommet. 1 slim metal leg. Must use storage module 27" H (690 mm) as support. Can accommodate 1 modular modesty panel.</i>				
84 x 36 x 29½	2100 x 900 x 752	N_NNN-RS3684PD6	1,961	2,298
78 x 36 x 29½	1950 x 900 x 752	N_NNN-RS3678PD6	1,891	2,256
72 x 36 x 29½	1800 x 900 x 752	N_NNN-RS3672PD6	1,826	2,205
66 x 36 x 29½	1650 x 900 x 752	N_NNN-RS3666PD6	1,768	2,156
60 x 36 x 29½	1500 x 900 x 752	N_NNN-RS3660PD6	1,706	2,112
Specify the surface type (1, 2).				
84 x 36 x 29½	2100 x 900 x 752	N_NNN-RS3684PD6	2,118	2,464
78 x 36 x 29½	1950 x 900 x 752	N_NNN-RS3678PD6	2,040	2,404
72 x 36 x 29½	1800 x 900 x 752	N_NNN-RS3672PD6	1,961	2,349
66 x 36 x 29½	1650 x 900 x 752	N_NNN-RS3666PD6	1,891	2,292
60 x 36 x 29½	1500 x 900 x 752	N_NNN-RS3660PD6	1,812	2,235
Specify the surface type (5, 6).				
84 x 36 x 29½	2100 x 900 x 752	N_KNN-RS3684PD6	2,305	2,650
78 x 36 x 29½	1950 x 900 x 752	N_KNN-RS3678PD6	2,220	2,593
72 x 36 x 29½	1800 x 900 x 752	N_KNN-RS3672PD6	2,142	2,536
66 x 36 x 29½	1650 x 900 x 752	N_KNN-RS3666PD6	2,061	2,485
60 x 36 x 29½	1500 x 900 x 752	N_KNN-RS3660PD6	1,990	2,427
Knife edge (K). Specify the surface type (5, 6).				

W x D x H (in)	W x D x H (mm)	Code	All Laminate (\$)	HPL Surfaces (\$)
Rectangular surfaces, 1 strut, 1 slim metal leg – 30" D				
<i>Surface with strut. Meeting space. 1 grommet. 1 slim metal leg. Must use storage module 27" H (690 mm) as support. Can accommodate 1 modular modesty panel.</i>				
84 x 30 x 29½	2100 x 750 x 752	N_NNN-RS3084PD6	1,949	2,247
78 x 30 x 29½	1950 x 750 x 752	N_NNN-RS3078PD6	1,876	2,198
72 x 30 x 29½	1800 x 750 x 752	N_NNN-RS3072PD6	1,812	2,156
66 x 30 x 29½	1650 x 750 x 752	N_NNN-RS3066PD6	1,756	2,107
60 x 30 x 29½	1500 x 750 x 752	N_NNN-RS3060PD6	1,698	2,061
Specify the surface type (1, 2).				
84 x 30 x 29½	2100 x 750 x 752	N_NNN-RS3084PD6	2,089	2,391
78 x 30 x 29½	1950 x 750 x 752	N_NNN-RS3078PD6	2,005	2,335
72 x 30 x 29½	1800 x 750 x 752	N_NNN-RS3072PD6	1,934	2,278
66 x 30 x 29½	1650 x 750 x 752	N_NNN-RS3066PD6	1,854	2,220
60 x 30 x 29½	1500 x 750 x 752	N_NNN-RS3060PD6	1,783	2,162
Specify the surface type (5, 6).				
84 x 30 x 29½	2100 x 750 x 752	N_KNN-RS3084PD6	2,284	2,593
78 x 30 x 29½	1950 x 750 x 752	N_KNN-RS3078PD6	2,205	2,536
72 x 30 x 29½	1800 x 750 x 752	N_KNN-RS3072PD6	2,129	2,477
66 x 30 x 29½	1650 x 750 x 752	N_KNN-RS3066PD6	2,048	2,427
60 x 30 x 29½	1500 x 750 x 752	N_KNN-RS3060PD6	1,977	2,371
Knife edge (K). Specify the surface type (5, 6).				

W x D x H (in)	W x D x H (mm)	Code	All Laminate (\$)	HPL Surfaces (\$)
Rectangular surfaces, 1 strut, 1 slim metal leg – 24" D				
<i>Surface with strut. Meeting space. 1 grommet. 1 slim metal leg. Must use storage module 27" H (690 mm) as support. Can accommodate 1 modular modesty panel.</i>				
78 x 24 x 29½	1950 x 600 x 752	N_NNN-RS2478PD6	1,717	2,148
72 x 24 x 29½	1800 x 600 x 752	N_NNN-RS2472PD6	1,689	2,107
66 x 24 x 29½	1650 x 600 x 752	N_NNN-RS2466PD6	1,669	2,056
60 x 24 x 29½	1500 x 600 x 752	N_NNN-RS2460PD6	1,648	2,012
Specify the surface type (1, 2).				
78 x 24 x 29½	1950 x 600 x 752	N_NNN-RS2478PD6	1,818	2,263
72 x 24 x 29½	1800 x 600 x 752	N_NNN-RS2472PD6	1,783	2,205
66 x 24 x 29½	1650 x 600 x 752	N_NNN-RS2466PD6	1,756	2,156
60 x 24 x 29½	1500 x 600 x 752	N_NNN-RS2460PD6	1,726	2,097
Specify the surface type (5, 6).				
78 x 24 x 29½	1950 x 600 x 752	N_KNN-RS2478PD6	2,012	2,470
72 x 24 x 29½	1800 x 600 x 752	N_KNN-RS2472PD6	1,984	2,422
66 x 24 x 29½	1650 x 600 x 752	N_KNN-RS2466PD6	1,954	2,364
60 x 24 x 29½	1500 x 600 x 752	N_KNN-RS2460PD6	1,918	2,314
Knife edge (K). Specify the surface type (5, 6).				

RETURN-SURFACES

W x D x H (in)	W x D x H (mm)	Code	All Laminate (\$)	HPL Surfaces (\$)
Rectangular return-surfaces, 1 slim metal leg – 36" D				
<i>Must be secured to another surface. Meeting space. Can accommodate 1 modular modesty panel.</i>				
72 x 36 x 29½	1800 x 900 x 752	N_NNN-RS3672P	1,689	1,977
66 x 36 x 29½	1650 x 900 x 752	N_NNN-RS3666P	1,669	1,942
60 x 36 x 29½	1500 x 900 x 752	N_NNN-RS3660P	1,648	1,899
Specify the surface type (1, 2).				
72 x 36 x 29½	1800 x 900 x 752	N_NNN-RS3672P	1,826	2,118
66 x 36 x 29½	1650 x 900 x 752	N_NNN-RS3666P	1,798	2,070
60 x 36 x 29½	1500 x 900 x 752	N_NNN-RS3660P	1,768	2,020
Specify the surface type (5, 6).				
72 x 36 x 29½	1800 x 900 x 752	N_KNN-RS3672P	2,040	2,341
66 x 36 x 29½	1650 x 900 x 752	N_KNN-RS3666P	2,005	2,284
60 x 36 x 29½	1500 x 900 x 752	N_KNN-RS3660P	1,969	2,227
Knife edge (K). Specify the surface type (5, 6).				

W x D x H (in)	W x D x H (mm)	Code	All Laminate (\$)	HPL Surfaces (\$)
Rectangular return-surfaces, 1 slim metal leg – 30" D				
<i>Must be secured to another surface. Meeting space. Can accommodate 1 modular modesty panel.</i>				
72 x 30 x 29½	1800 x 750 x 752	N_NNN-RS3072P	1,656	1,905
66 x 30 x 29½	1650 x 750 x 752	N_NNN-RS3066P	1,633	1,863
60 x 30 x 29½	1500 x 750 x 752	N_NNN-RS3060P	1,611	1,826
Specify the surface type (1, 2).				
72 x 30 x 29½	1800 x 750 x 752	N_NNN-RS3072P	1,762	2,020
66 x 30 x 29½	1650 x 750 x 752	N_NNN-RS3066P	1,739	1,969
60 x 30 x 29½	1500 x 750 x 752	N_NNN-RS3060P	1,711	1,926
Specify the surface type (5, 6).				
72 x 30 x 29½	1800 x 750 x 752	N_KNN-RS3072P	1,984	2,241
66 x 30 x 29½	1650 x 750 x 752	N_KNN-RS3066P	1,949	2,185
60 x 30 x 29½	1500 x 750 x 752	N_KNN-RS3060P	1,913	2,134
Knife edge (K). Specify the surface type (5, 6).				

W x D x H (in)	W x D x H (mm)	Code	All Laminate (\$)	HPL Surfaces (\$)
Rectangular return-surfaces, 1 slim metal leg – 24" D				
<i>Must be secured to another surface. Meeting space. Can accommodate 1 modular modesty panel.</i>				
72 x 24 x 29½	1800 x 600 x 752	N_NNN-RS2472P	1,611	1,826
66 x 24 x 29½	1650 x 600 x 752	N_NNN-RS2466P	1,597	1,792
60 x 24 x 29½	1500 x 600 x 752	N_NNN-RS2460P	1,576	1,756
Specify the surface type (1, 2).				
72 x 24 x 29½	1800 x 600 x 752	N_NNN-RS2472P	1,698	1,918
66 x 24 x 29½	1650 x 600 x 752	N_NNN-RS2466P	1,675	1,876
60 x 24 x 29½	1500 x 600 x 752	N_NNN-RS2460P	1,661	1,834
Specify the surface type (5, 6).				
72 x 24 x 29½	1800 x 600 x 752	N_KNN-RS2472P	1,918	2,142
66 x 24 x 29½	1650 x 600 x 752	N_KNN-RS2466P	1,891	2,090
60 x 24 x 29½	1500 x 600 x 752	N_KNN-RS2460P	1,854	2,040
Knife edge (K). Specify the surface type (5, 6).				

RETURNS

W x D x H (in)	W x D x H (mm)	Code	All Laminate (\$)	HPL Surfaces (\$)
Rectangular returns, short back, 1 long leg – 24" D				
<i>3" (75 mm) recessed short back. 1 grommet. Can accommodate 1 storage module 21" H (561 mm) and must be secured to another surface. Can accommodate 1 modular modesty panel.</i>				
72 x 24 x 29½	1800 x 600 x 752	N_N_N-R2472A5	896	1,127
66 x 24 x 29½	1650 x 600 x 752	N_N_N-R2466A5	870	1,088
60 x 24 x 29½	1500 x 600 x 752	N_N_N-R2460A5	847	1,054
54 x 24 x 29½	1350 x 600 x 752	N_N_N-R2454A5	831	1,008
48 x 24 x 29½	1200 x 600 x 752	N_N_N-R2448A5	798	967
Specify the surface type (1, 2). Specify left (L) or right (R).				
72 x 24 x 29½	1800 x 600 x 752	N_N_N-R2472A5	960	1,193
66 x 24 x 29½	1650 x 600 x 752	N_N_N-R2466A5	935	1,152
60 x 24 x 29½	1500 x 600 x 752	N_N_N-R2460A5	896	1,096
54 x 24 x 29½	1350 x 600 x 752	N_N_N-R2454A5	870	1,054
48 x 24 x 29½	1200 x 600 x 752	N_N_N-R2448A5	847	998
Specify the surface type (5, 6). Specify left (L) or right (R).				
72 x 24 x 29½	1800 x 600 x 752	N_K_N-R2472A5	1,219	1,452
66 x 24 x 29½	1650 x 600 x 752	N_K_N-R2466A5	1,193	1,411
60 x 24 x 29½	1500 x 600 x 752	N_K_N-R2460A5	1,169	1,371
54 x 24 x 29½	1350 x 600 x 752	N_K_N-R2454A5	1,127	1,317
48 x 24 x 29½	1200 x 600 x 752	N_K_N-R2448A5	1,102	1,274
Knife edge (K). Specify the surface type (5, 6). Specify left (L) or right (R).				

W x D x H (in)	W x D x H (mm)	Code	All Laminate (\$)	HPL Surfaces (\$)
Rectangular returns, short back, 1 long leg – 20" D				
3" (75 mm) recessed short back. 1 grommet. Can accommodate 1 storage module 21" H (561 mm) and must be secured to another surface. Can accommodate 1 modular modesty panel.				
72 x 20 x 29½	1800 x 500 x 752	N_N_N-R2072A5	870	1,071
66 x 20 x 29½	1650 x 500 x 752	N_N_N-R2066A5	847	1,021
60 x 20 x 29½	1500 x 500 x 752	N_N_N-R2060A5	831	993
54 x 20 x 29½	1350 x 500 x 752	N_N_N-R2054A5	798	951
48 x 20 x 29½	1200 x 500 x 752	N_N_N-R2048A5	779	912
Specify the surface type (1, 2). Specify left (L) or right (R).				
72 x 20 x 29½	1800 x 500 x 752	N_N_N-R2072A5	912	1,114
66 x 20 x 29½	1650 x 500 x 752	N_N_N-R2066A5	885	1,071
60 x 20 x 29½	1500 x 500 x 752	N_N_N-R2060A5	862	1,021
54 x 20 x 29½	1350 x 500 x 752	N_N_N-R2054A5	839	984
48 x 20 x 29½	1200 x 500 x 752	N_N_N-R2048A5	805	951
Specify the surface type (5, 6). Specify left (L) or right (R).				
72 x 20 x 29½	1800 x 500 x 752	N_K_N-R2072A5	1,176	1,379
66 x 20 x 29½	1650 x 500 x 752	N_K_N-R2066A5	1,152	1,329
60 x 20 x 29½	1500 x 500 x 752	N_K_N-R2060A5	1,119	1,289
54 x 20 x 29½	1350 x 500 x 752	N_K_N-R2054A5	1,096	1,256
48 x 20 x 29½	1200 x 500 x 752	N_K_N-R2048A5	1,080	1,211
Knife edge (K). Specify the surface type (5, 6). Specify left (L) or right (R).				

W x D x H (in)	W x D x H (mm)	Code	All Laminate (\$)	HPL Surfaces (\$)
Rectangular returns, short back, 1 short leg – 24" D				
3" (75 mm) recessed short back. 1 grommet. Must use 1 storage module 21" H (561 mm) as support and be secured to another surface. Can accommodate 1 modular modesty panel.				
72 x 24 x 7½	1800 x 600 x 191	N_N_N-R2472B5	791	1,015
66 x 24 x 7½	1650 x 600 x 191	N_N_N-R2466B5	766	973
60 x 24 x 7½	1500 x 600 x 191	N_N_N-R2460B5	742	942
54 x 24 x 7½	1350 x 600 x 191	N_N_N-R2454B5	724	896
48 x 24 x 7½	1200 x 600 x 191	N_N_N-R2448B5	694	856
Specify the surface type (1, 2). Specify left (L) or right (R).				
72 x 24 x 7½	1800 x 600 x 191	N_N_N-R2472B5	847	1,071
66 x 24 x 7½	1650 x 600 x 191	N_N_N-R2466B5	823	1,021
60 x 24 x 7½	1500 x 600 x 191	N_N_N-R2460B5	791	973
54 x 24 x 7½	1350 x 600 x 191	N_N_N-R2454B5	766	935
48 x 24 x 7½	1200 x 600 x 191	N_N_N-R2448B5	742	885
Specify the surface type (5, 6). Specify left (L) or right (R).				
72 x 24 x 7½	1800 x 600 x 191	N_K_N-R2472B5	1,102	1,329
66 x 24 x 7½	1650 x 600 x 191	N_K_N-R2466B5	1,080	1,289
60 x 24 x 7½	1500 x 600 x 191	N_K_N-R2460B5	1,054	1,242
54 x 24 x 7½	1350 x 600 x 191	N_K_N-R2454B5	1,021	1,193
48 x 24 x 7½	1200 x 600 x 191	N_K_N-R2448B5	998	1,152
Knife edge (K). Specify the surface type (5, 6). Specify left (L) or right (R).				

W x D x H (in)	W x D x H (mm)	Code	All Laminate (\$)	HPL Surfaces (\$)
Rectangular returns, short back, 1 short leg – 20" D				
3" (75 mm) recessed short back. 1 grommet. Must use 1 storage module 21" H (561 mm) as support and be secured to another surface. Can accommodate 1 modular modesty panel.				
72 x 20 x 7½	1800 x 500 x 191	N_N_N-R2072B5	766	967
66 x 20 x 7½	1650 x 500 x 191	N_N_N-R2066B5	752	935
60 x 20 x 7½	1500 x 500 x 191	N_N_N-R2060B5	731	896
54 x 20 x 7½	1350 x 500 x 191	N_N_N-R2054B5	701	856
48 x 20 x 7½	1200 x 500 x 191	N_N_N-R2048B5	686	823
Specify the surface type (1, 2). Specify left (L) or right (R).				
72 x 20 x 7½	1800 x 500 x 191	N_N_N-R2072B5	823	1,008
66 x 20 x 7½	1650 x 500 x 191	N_N_N-R2066B5	791	967
60 x 20 x 7½	1500 x 500 x 191	N_N_N-R2060B5	766	935
54 x 20 x 7½	1350 x 500 x 191	N_N_N-R2054B5	742	885
48 x 20 x 7½	1200 x 500 x 191	N_N_N-R2048B5	718	847
Specify the surface type (5, 6). Specify left (L) or right (R).				
72 x 20 x 7½	1800 x 500 x 191	N_K_N-R2072B5	1,080	1,274
66 x 20 x 7½	1650 x 500 x 191	N_K_N-R2066B5	1,054	1,225
60 x 20 x 7½	1500 x 500 x 191	N_K_N-R2060B5	1,021	1,193
54 x 20 x 7½	1350 x 500 x 191	N_K_N-R2054B5	998	1,152
48 x 20 x 7½	1200 x 500 x 191	N_K_N-R2048B5	973	1,102
Knife edge (K). Specify the surface type (5, 6). Specify left (L) or right (R).				

Returns, 1 strut – 24" D

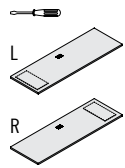

W x D x H (in)	W x D x H (mm)	Code	All Laminate (\$)	HPL Surfaces (\$)
Surface with strut. 1 grommet. Must use storage module 27" H (690 mm) as support and be secured to another surface. Can accommodate 1 modular modesty panel.				
72 x 24 x 2½	1800 x 600 x 63,5	N_N_N-R2472D6	553	717
66 x 24 x 2½	1650 x 600 x 63,5	N_N_N-R2466D6	536	687
60 x 24 x 2½	1500 x 600 x 63,5	N_N_N-R2460D6	524	659
54 x 24 x 2½	1350 x 600 x 63,5	N_N_N-R2454D6	510	630
48 x 24 x 2½	1200 x 600 x 63,5	N_N_N-R2448D6	493	603
Specify the surface type (1, 2). Specify left (L) or right (R).				
72 x 24 x 2½	1800 x 600 x 63,5	N_N_N-R2472D6	653	809
66 x 24 x 2½	1650 x 600 x 63,5	N_N_N-R2466D6	622	773
60 x 24 x 2½	1500 x 600 x 63,5	N_N_N-R2460D6	603	745
54 x 24 x 2½	1350 x 600 x 63,5	N_N_N-R2454D6	581	710
48 x 24 x 2½	1200 x 600 x 63,5	N_N_N-R2448D6	558	672
Specify the surface type (5, 6). Specify left (L) or right (R).				
72 x 24 x 2½	1800 x 600 x 63,5	N_K_N-R2472D6	853	1,016
66 x 24 x 2½	1650 x 600 x 63,5	N_K_N-R2466D6	824	972
60 x 24 x 2½	1500 x 600 x 63,5	N_K_N-R2460D6	796	933
54 x 24 x 2½	1350 x 600 x 63,5	N_K_N-R2454D6	766	881
48 x 24 x 2½	1200 x 600 x 63,5	N_K_N-R2448D6	737	838
Knife edge (K). Specify the surface type (5, 6). Specify left (L) or right (R).				

Returns, 1 strut – 20" D

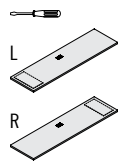

W x D x H (in)	W x D x H (mm)	Code	All Laminate (\$)	HPL Surfaces (\$)
Surface with strut. 1 grommet. Must use storage module 27" H (690 mm) as support and be secured to another surface. Can accommodate 1 modular modesty panel.				
72 x 20 x 2½	1800 x 500 x 63,5	N_N_N-R2072D6	516	659
66 x 20 x 2½	1650 x 500 x 63,5	N_N_N-R2066D6	510	630
60 x 20 x 2½	1500 x 500 x 63,5	N_N_N-R2060D6	493	609
54 x 20 x 2½	1350 x 500 x 63,5	N_N_N-R2054D6	480	581
48 x 20 x 2½	1200 x 500 x 63,5	N_N_N-R2048D6	464	553
Specify the surface type (1, 2). Specify left (L) or right (R).				
72 x 20 x 2½	1800 x 500 x 63,5	N_N_N-R2072D6	609	745
66 x 20 x 2½	1650 x 500 x 63,5	N_N_N-R2066D6	593	717
60 x 20 x 2½	1500 x 500 x 63,5	N_N_N-R2060D6	571	680
54 x 20 x 2½	1350 x 500 x 63,5	N_N_N-R2054D6	553	653
48 x 20 x 2½	1200 x 500 x 63,5	N_N_N-R2048D6	530	617
Specify the surface type (5, 6). Specify left (L) or right (R).				
72 x 20 x 2½	1800 x 500 x 63,5	N_K_N-R2072D6	803	938
66 x 20 x 2½	1650 x 500 x 63,5	N_K_N-R2066D6	779	896
60 x 20 x 2½	1500 x 500 x 63,5	N_K_N-R2060D6	753	853
54 x 20 x 2½	1350 x 500 x 63,5	N_K_N-R2054D6	723	809
48 x 20 x 2½	1200 x 500 x 63,5	N_K_N-R2048D6	695	773
Knife edge (K). Specify the surface type (5, 6). Specify left (L) or right (R).				

ELECTRIC HEIGHT ADJUSTABLE DESKS AND RETURNS

Electric height adjustable desks with 21" H file storage module – 36" D

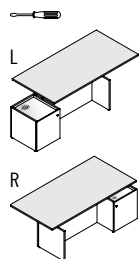

Laminate base with metal back. Meeting space. Height adjustable from 26" to 44" H (661 to 1118 mm). Open space with felt liner to store small objects. Removable inside panel for wire management. Maximum weight capacity: 100 lbs (45 kg). 10" W (3048 mm) cable with cord. 1 file drawer with soft-close. Lock. To add a grommet/electrical module, refer to Standardized specials on page 15.

W x D x H (in)	W x D x H (mm)	Code	All Laminate (\$)	HPL Surfaces (\$)
92 x 36 x 26-43½	2300 x 900 x 661-1105	N_N_N-RT3684FG	6,014	6,444
86 x 36 x 26-43½	2150 x 900 x 661-1105	N_N_N-RT3678FG	5,979	6,389
80 x 36 x 26-43½	2000 x 900 x 661-1105	N_N_N-RT3672FG	5,936	6,338
74 x 36 x 26-43½	1850 x 900 x 661-1105	N_N_N-RT3666FG	5,902	6,282
Specify the surface type (5, 6). Specify left (L) or right (R). Specify the drawer front finish (B, W, N) Specify metal back color (K, W).				
92 x 36 x 26-43½	2300 x 900 x 661-1105	N_K_N-RT3684FG	6,202	6,637
86 x 36 x 26-43½	2150 x 900 x 661-1105	N_K_N-RT3678FG	6,165	6,580
80 x 36 x 26-43½	2000 x 900 x 661-1105	N_K_N-RT3672FG	6,121	6,524
74 x 36 x 26-43½	1850 x 900 x 661-1105	N_K_N-RT3666FG	6,087	6,473
Knife edge (K). Specify the surface type (5, 6). Specify left (L) or right (R). Specify the drawer front finish (B, W, N) Specify metal back color (K, W).				

High-Gloss Black (B) or High-Gloss White (W) drawer front finish option: add \$81.

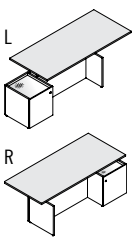
	W x D x H (in)	W x D x H (mm)	Code	All Laminate (\$)	HPL Surfaces (\$)
Electric height adjustable desks with 21" H file storage module – 32" D 	<i>Laminate base with metal back. Meeting space. Height adjustable from 26" to 44" H (661 to 1118 mm). Open space with felt liner to store small objects. Removable inside panel for wire management. Maximum weight capacity: 100 lbs (45 kg). 10' W (3048 mm) cable with cord. 1 file drawer with soft-close. Lock. To add a grommet/electrical module, refer to Standardized specials on page 15.</i>				
	92 x 32 x 26-43½	2300 x 800 x 661-1105	N_N_-RT3284FG	5,973	6,373
	86 x 32 x 26-43½	2150 x 800 x 661-1105	N_N_-RT3278FG	5,930	6,316
	80 x 32 x 26-43½	2000 x 800 x 661-1105	N_N_-RT3272FG	5,893	6,265
	74 x 32 x 26-43½	1850 x 800 x 661-1105	N_N_-RT3266FG	5,858	6,209
Specify the surface type (5, 6). Specify left (L) or right (R). Specify the drawer front finish (B, W, N) Specify metal back color (K, W).					
	92 x 32 x 26-43½	2300 x 800 x 661-1105	N_K_-RT3284FG	6,158	6,568
	86 x 32 x 26-43½	2150 x 800 x 661-1105	N_K_-RT3278FG	6,115	6,508
	80 x 32 x 26-43½	2000 x 800 x 661-1105	N_K_-RT3272FG	6,079	6,451
	74 x 32 x 26-43½	1850 x 800 x 661-1105	N_K_-RT3266FG	6,037	6,394

High-Gloss Black (B) or High-Gloss White (W) drawer front finish option: add \$81.

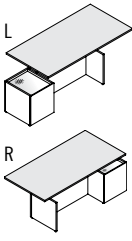
	W x D x H (in)	W x D x H (mm)	Code	All Laminate (\$)	HPL Surfaces (\$)
Electric height adjustable desks – 36" D 	<i>Laminate base with metal back. Meeting space. Height adjustable from 26" to 44" H (661 to 1118 mm). Open space with felt liner to store small objects. Removable inside panel for wire management. Maximum weight capacity: 100 lbs (45 kg). 10' W (3048 mm) cable with cord. To add a grommet/electrical module, refer to Standardized specials on page 15.</i>				
	92 x 36 x 26-43½	2300 x 900 x 661-1105	N_N_-RT3684SG	5,843	6,271
	86 x 36 x 26-43½	2150 x 900 x 661-1105	N_N_-RT3678SG	5,807	6,215
	80 x 36 x 26-43½	2000 x 900 x 661-1105	N_N_-RT3672SG	5,772	6,158
	74 x 36 x 26-43½	1850 x 900 x 661-1105	N_N_-RT3666SG	5,736	6,108
Specify the surface type (5, 6). Specify left (L) or right (R). Specify the inside casing front finish (B, W, N) Specify metal back color (K, W).					
	92 x 36 x 26-43½	2300 x 900 x 661-1105	N_K_-RT3684SG	6,037	6,466
	86 x 36 x 26-43½	2150 x 900 x 661-1105	N_K_-RT3678SG	5,992	6,410
	80 x 36 x 26-43½	2000 x 900 x 661-1105	N_K_-RT3672SG	5,957	6,352
	74 x 36 x 26-43½	1850 x 900 x 661-1105	N_K_-RT3666SG	5,914	6,294

High-Gloss Black (B) or High-Gloss White (W) inside housing front finish option: add \$81.

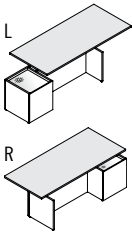
	W x D x H (in)	W x D x H (mm)	Code	All Laminate (\$)	HPL Surfaces (\$)
Electric height adjustable desks – 32" D 	<i>Laminate base with metal back. Meeting space. Height adjustable from 26" to 44" H (661 to 1118 mm). Open space with felt liner to store small objects. Removable inside panel for wire management. Maximum weight capacity: 100 lbs (45 kg). 10' W (3048 mm) cable with cord. To add a grommet/electrical module, refer to Standardized specials on page 15.</i>				
	92 x 32 x 26-43½	2300 x 800 x 661-1105	N_N_-RT3284SG	5,801	6,202
	86 x 32 x 26-43½	2150 x 800 x 661-1105	N_N_-RT3278SG	5,765	6,144
	80 x 32 x 26-43½	2000 x 800 x 661-1105	N_N_-RT3272SG	5,728	6,087
	74 x 32 x 26-43½	1850 x 800 x 661-1105	N_N_-RT3266SG	5,686	6,037
Specify the surface type (5, 6). Specify left (L) or right (R). Specify the inside casing front finish (B, W, N) Specify metal back color (K, W).					
	92 x 32 x 26-43½	2300 x 800 x 661-1105	N_K_-RT3284SG	5,986	6,389
	86 x 32 x 26-43½	2150 x 800 x 661-1105	N_K_-RT3278SG	5,952	6,338
	80 x 32 x 26-43½	2000 x 800 x 661-1105	N_K_-RT3272SG	5,908	6,282
	74 x 32 x 26-43½	1850 x 800 x 661-1105	N_K_-RT3266SG	5,873	6,222

High-Gloss Black (B) or High-Gloss White (W) inside housing front finish option: add \$81.

L-shaped electric height adjustable desks with 24" D return and 21" H file storage module

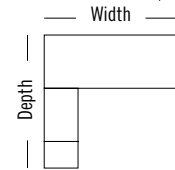
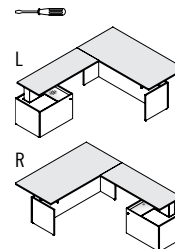

High-Gloss Black (B) or High-Gloss White (W) return drawer front finish option: add \$122.

	W x D x H (in)	W x D x H (mm)	Code	All Laminate (\$)	HPL Surfaces (\$)
<i>Laminate base with metal back. Meeting space. Height adjustable from 26" to 44" H (661 to 1118 mm). 1 return with file drawer and soft-close. Suspension bar. Lock. Open space with felt liner to store small objects. Removable inside panel for wire management. Maximum weight capacity: 100 lbs (45 kg). 10' W (3048 mm) cable with cord. To add a grommet/electrical module, refer to Standardized specials on page 15.</i>					
	84 x 102 x 26-43½	2100 x 2550 x 661-1105	N_N_-RTL8410224FG	9,439	9,989
	84 x 96 x 26-43½	2100 x 2400 x 661-1105	N_N_-RTL849624FG	9,417	9,962
	84 x 90 x 26-43½	2100 x 2250 x 661-1105	N_N_-RTL849024FG	9,394	9,932
	84 x 84 x 26-43½	2100 x 2100 x 661-1105	N_N_-RTL848424FG	9,374	9,910
	84 x 78 x 26-43½	2100 x 1950 x 661-1105	N_N_-RTL847824FG	9,359	9,882
	84 x 72 x 26-43½	2100 x 1800 x 661-1105	N_N_-RTL847224FG	9,338	9,851
	78 x 102 x 26-43½	1950 x 2550 x 661-1105	N_N_-RTL7810224FG	9,388	9,917
	78 x 96 x 26-43½	1950 x 2400 x 661-1105	N_N_-RTL789624FG	9,365	9,887
	78 x 90 x 26-43½	1950 x 2250 x 661-1105	N_N_-RTL789024FG	9,346	9,869
	78 x 84 x 26-43½	1950 x 2100 x 661-1105	N_N_-RTL788424FG	9,323	9,837
	78 x 78 x 26-43½	1950 x 1950 x 661-1105	N_N_-RTL787824FG	9,302	9,810
	78 x 72 x 26-43½	1950 x 1800 x 661-1105	N_N_-RTL787224FG	9,279	9,788
	72 x 102 x 26-43½	1800 x 2550 x 661-1105	N_N_-RTL7210224FG	9,329	9,851
	72 x 96 x 26-43½	1800 x 2400 x 661-1105	N_N_-RTL729624FG	9,315	9,825
	72 x 90 x 26-43½	1800 x 2250 x 661-1105	N_N_-RTL729024FG	9,296	9,796
	72 x 84 x 26-43½	1800 x 2100 x 661-1105	N_N_-RTL728424FG	9,274	9,775
	72 x 78 x 26-43½	1800 x 1950 x 661-1105	N_N_-RTL727824FG	9,252	9,745
	72 x 72 x 26-43½	1800 x 1800 x 661-1105	N_N_-RTL727224FG	9,229	9,718
	66 x 102 x 26-43½	1650 x 2550 x 661-1105	N_N_-RTL6610224FG	9,279	9,781
	66 x 96 x 26-43½	1650 x 2400 x 661-1105	N_N_-RTL669624FG	9,259	9,753
	66 x 90 x 26-43½	1650 x 2250 x 661-1105	N_N_-RTL669024FG	9,239	9,732
	66 x 84 x 26-43½	1650 x 2100 x 661-1105	N_N_-RTL668424FG	9,223	9,702
	66 x 78 x 26-43½	1650 x 1950 x 661-1105	N_N_-RTL667824FG	9,202	9,675
	66 x 72 x 26-43½	1650 x 1800 x 661-1105	N_N_-RTL667224FG	9,179	9,652
Specify the surface type (5, 6). Specify left (L) or right (R). Specify the return drawer front finish (B, W, N). Specify metal back color (K, W).					
	84 x 102 x 26-43½	2100 x 2550 x 661-1105	N_K_-RTL8410224FG	9,796	10,363
	84 x 96 x 26-43½	2100 x 2400 x 661-1105	N_K_-RTL849624FG	9,775	10,331
	84 x 90 x 26-43½	2100 x 2250 x 661-1105	N_K_-RTL849024FG	9,753	10,304
	84 x 84 x 26-43½	2100 x 2100 x 661-1105	N_K_-RTL848424FG	9,732	10,275
	84 x 78 x 26-43½	2100 x 1950 x 661-1105	N_K_-RTL847824FG	9,708	10,247
	84 x 72 x 26-43½	2100 x 1800 x 661-1105	N_K_-RTL847224FG	9,688	10,225
	78 x 102 x 26-43½	1950 x 2550 x 661-1105	N_K_-RTL7810224FG	9,745	10,291
	78 x 96 x 26-43½	1950 x 2400 x 661-1105	N_K_-RTL789624FG	9,725	10,261
	78 x 90 x 26-43½	1950 x 2250 x 661-1105	N_K_-RTL789024FG	9,702	10,233
	78 x 84 x 26-43½	1950 x 2100 x 661-1105	N_K_-RTL788424FG	9,681	10,206
	78 x 78 x 26-43½	1950 x 1950 x 661-1105	N_K_-RTL787824FG	9,660	10,183
	78 x 72 x 26-43½	1950 x 1800 x 661-1105	N_K_-RTL787224FG	9,638	10,155
	72 x 102 x 26-43½	1800 x 2550 x 661-1105	N_K_-RTL7210224FG	9,688	10,218
	72 x 96 x 26-43½	1800 x 2400 x 661-1105	N_K_-RTL729624FG	9,668	10,189
	72 x 90 x 26-43½	1800 x 2250 x 661-1105	N_K_-RTL729024FG	9,645	10,161
	72 x 84 x 26-43½	1800 x 2100 x 661-1105	N_K_-RTL728424FG	9,625	10,132
	72 x 78 x 26-43½	1800 x 1950 x 661-1105	N_K_-RTL727824FG	9,602	10,111
	72 x 72 x 26-43½	1800 x 1800 x 661-1105	N_K_-RTL727224FG	9,580	10,082
	66 x 102 x 26-43½	1650 x 2550 x 661-1105	N_K_-RTL6610224FG	9,638	10,148
	66 x 96 x 26-43½	1650 x 2400 x 661-1105	N_K_-RTL669624FG	9,617	10,117
	66 x 90 x 26-43½	1650 x 2250 x 661-1105	N_K_-RTL669024FG	9,595	10,088
	66 x 84 x 26-43½	1650 x 2100 x 661-1105	N_K_-RTL668424FG	9,574	10,068
	66 x 78 x 26-43½	1650 x 1950 x 661-1105	N_K_-RTL667824FG	9,552	10,038
	66 x 72 x 26-43½	1650 x 1800 x 661-1105	N_K_-RTL667224FG	9,531	10,011
Knife edge (K). Specify the surface type (5, 6). Specify left (L) or right (R). Specify the return drawer front finish (B, W, N). Specify metal back color (K, W).					

L-shaped electric height adjustable desks with 20" D return and 21" H file storage module

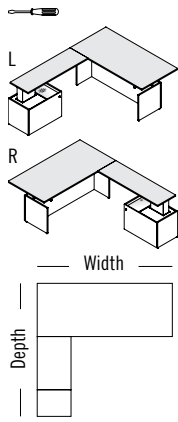

High-Gloss Black (B) or High-Gloss White (W) return drawer front finish option: add \$122.

Laminate base with metal back. Meeting space. Height adjustable from 26" to 44" H (661 to 1118 mm). 1 return with file drawer and soft-close. Suspension bar. Lock. Open space with felt liner to store small objects. Removable inside panel for wire management. Maximum weight capacity: 100 lbs (45 kg). 10' W (3048 mm) cable with cord. To add a grommet/electrical module, refer to Standardized specials on page 15.

W x D x H (in)	W x D x H (mm)	Code	All Laminate Surfaces (\$)	HPL Surfaces (\$)
84 x 102 x 26-43½	2100 x 2550 x 661-1105	N N -RTL8410220FG	9,388	9,932
84 x 96 x 26-43½	2100 x 2400 x 661-1105	N N -RTL849620FG	9,365	9,903
84 x 90 x 26-43½	2100 x 2250 x 661-1105	N N -RTL849020FG	9,346	9,882
84 x 84 x 26-43½	2100 x 2100 x 661-1105	N N -RTL848420FG	9,323	9,851
84 x 78 x 26-43½	2100 x 1950 x 661-1105	N N -RTL847820FG	9,302	9,825
84 x 72 x 26-43½	2100 x 1800 x 661-1105	N N -RTL847220FG	9,279	9,803
78 x 102 x 26-43½	1950 x 2550 x 661-1105	N N -RTL7810220FG	9,352	9,882
78 x 96 x 26-43½	1950 x 2400 x 661-1105	N N -RTL789620FG	9,329	9,851
78 x 90 x 26-43½	1950 x 2250 x 661-1105	N N -RTL789020FG	9,310	9,832
78 x 84 x 26-43½	1950 x 2100 x 661-1105	N N -RTL788420FG	9,288	9,803
78 x 78 x 26-43½	1950 x 1950 x 661-1105	N N -RTL787820FG	9,266	9,775
78 x 72 x 26-43½	1950 x 1800 x 661-1105	N N -RTL787220FG	9,252	9,753
72 x 102 x 26-43½	1800 x 2550 x 661-1105	N N -RTL7210220FG	9,315	9,825
72 x 96 x 26-43½	1800 x 2400 x 661-1105	N N -RTL729620FG	9,296	9,803
72 x 90 x 26-43½	1800 x 2250 x 661-1105	N N -RTL729020FG	9,274	9,781
72 x 84 x 26-43½	1800 x 2100 x 661-1105	N N -RTL728420FG	9,252	9,753
72 x 78 x 26-43½	1800 x 1950 x 661-1105	N N -RTL727820FG	9,239	9,725
72 x 72 x 26-43½	1800 x 1800 x 661-1105	N N -RTL727220FG	9,216	9,702
66 x 102 x 26-43½	1650 x 2550 x 661-1105	N N -RTL6610220FG	9,279	9,781
66 x 96 x 26-43½	1650 x 2400 x 661-1105	N N -RTL669620FG	9,259	9,753
66 x 90 x 26-43½	1650 x 2250 x 661-1105	N N -RTL669020FG	9,239	9,732
66 x 84 x 26-43½	1650 x 2100 x 661-1105	N N -RTL668420FG	9,223	9,702
66 x 78 x 26-43½	1650 x 1950 x 661-1105	N N -RTL667820FG	9,202	9,675
66 x 72 x 26-43½	1650 x 1800 x 661-1105	N N -RTL667220FG	9,179	9,652

Specify the surface type (5, 6). Specify left (L) or right (R). Specify the return drawer front finish (B, W, N). Specify metal back color (K, W).

84 x 102 x 26-43½	2100 x 2550 x 661-1105	N K -RTL8410220FG	9,745	10,304
84 x 96 x 26-43½	2100 x 2400 x 661-1105	N K -RTL849620FG	9,725	10,275
84 x 90 x 26-43½	2100 x 2250 x 661-1105	N K -RTL849020FG	9,702	10,247
84 x 84 x 26-43½	2100 x 2100 x 661-1105	N K -RTL848420FG	9,681	10,218
84 x 78 x 26-43½	2100 x 1950 x 661-1105	N K -RTL847820FG	9,660	10,196
84 x 72 x 26-43½	2100 x 1800 x 661-1105	N K -RTL847220FG	9,638	10,168
78 x 102 x 26-43½	1950 x 2550 x 661-1105	N K -RTL7810220FG	9,708	10,247
78 x 96 x 26-43½	1950 x 2400 x 661-1105	N K -RTL789620FG	9,688	10,225
78 x 90 x 26-43½	1950 x 2250 x 661-1105	N K -RTL789020FG	9,668	10,196
78 x 84 x 26-43½	1950 x 2100 x 661-1105	N K -RTL788420FG	9,645	10,168
78 x 78 x 26-43½	1950 x 1950 x 661-1105	N K -RTL787820FG	9,625	10,139
78 x 72 x 26-43½	1950 x 1800 x 661-1105	N K -RTL787220FG	9,602	10,117
72 x 102 x 26-43½	1800 x 2550 x 661-1105	N K -RTL7210220FG	9,675	10,196
72 x 96 x 26-43½	1800 x 2400 x 661-1105	N K -RTL729620FG	9,652	10,168
72 x 90 x 26-43½	1800 x 2250 x 661-1105	N K -RTL729020FG	9,630	10,148
72 x 84 x 26-43½	1800 x 2100 x 661-1105	N K -RTL728420FG	9,608	10,117
72 x 78 x 26-43½	1800 x 1950 x 661-1105	N K -RTL727820FG	9,590	10,088
72 x 72 x 26-43½	1800 x 1800 x 661-1105	N K -RTL727220FG	9,567	10,061
66 x 102 x 26-43½	1650 x 2550 x 661-1105	N K -RTL6610220FG	9,630	10,148
66 x 96 x 26-43½	1650 x 2400 x 661-1105	N K -RTL669620FG	9,617	10,117
66 x 90 x 26-43½	1650 x 2250 x 661-1105	N K -RTL669020FG	9,595	10,088
66 x 84 x 26-43½	1650 x 2100 x 661-1105	N K -RTL668420FG	9,574	10,068
66 x 78 x 26-43½	1650 x 1950 x 661-1105	N K -RTL667820FG	9,552	10,038
66 x 72 x 26-43½	1650 x 1800 x 661-1105	N K -RTL667220FG	9,531	10,011

Knife edge (K). Specify the surface type (5, 6). Specify left (L) or right (R). Specify the return drawer front finish (B, W, N). Specify metal back color (K, W).

L-shaped electric height adjustable desks with 24" D return

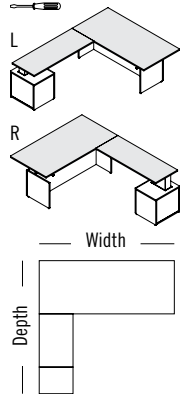

High-Gloss Black (B) or High-Gloss White (W) return inside housing front finish option: add \$122.

Laminate base with metal back. Meeting space. Height adjustable from 26" to 44" H (661 to 1118 mm). Removable inside panel for wire management. Maximum weight capacity: 100 lbs (45 kg). 10' W (3048 mm) cable with cord. To add a grommet/electrical module, refer to Standardized specials on page 15.

W x D x H (in)	W x D x H (mm)	Code	All Laminate Surfaces (\$)	HPL Surfaces (\$)
84 x 102 x 26-43½	2100 x 2550 x 661-1105	N N -RTL8410224SG	9,202	9,738
84 x 96 x 26-43½	2100 x 2400 x 661-1105	N N -RTL849624SG	9,179	9,708
84 x 90 x 26-43½	2100 x 2250 x 661-1105	N N -RTL849024SG	9,158	9,688
84 x 84 x 26-43½	2100 x 2100 x 661-1105	N N -RTL848424SG	9,137	9,660
84 x 78 x 26-43½	2100 x 1950 x 661-1105	N N -RTL847824SG	9,116	9,630
84 x 72 x 26-43½	2100 x 1800 x 661-1105	N N -RTL847224SG	9,095	9,608
78 x 102 x 26-43½	1950 x 2550 x 661-1105	N N -RTL7810224SG	9,145	9,668
78 x 96 x 26-43½	1950 x 2400 x 661-1105	N N -RTL789624SG	9,121	9,645
78 x 90 x 26-43½	1950 x 2250 x 661-1105	N N -RTL789024SG	9,109	9,617
78 x 84 x 26-43½	1950 x 2100 x 661-1105	N N -RTL788424SG	9,086	9,590
78 x 78 x 26-43½	1950 x 1950 x 661-1105	N N -RTL787824SG	9,066	9,567
78 x 72 x 26-43½	1950 x 1800 x 661-1105	N N -RTL787224SG	9,043	9,539
72 x 102 x 26-43½	1800 x 2550 x 661-1105	N N -RTL7210224SG	9,095	9,602
72 x 96 x 26-43½	1800 x 2400 x 661-1105	N N -RTL729624SG	9,072	9,574
72 x 90 x 26-43½	1800 x 2250 x 661-1105	N N -RTL729024SG	9,051	9,546
72 x 84 x 26-43½	1800 x 2100 x 661-1105	N N -RTL728424SG	9,031	9,523
72 x 78 x 26-43½	1800 x 1950 x 661-1105	N N -RTL727824SG	9,008	9,495
72 x 72 x 26-43½	1800 x 1800 x 661-1105	N N -RTL727224SG	8,993	9,466
66 x 102 x 26-43½	1650 x 2550 x 661-1105	N N -RTL6610224SG	9,043	9,531
66 x 96 x 26-43½	1650 x 2400 x 661-1105	N N -RTL669624SG	9,022	9,510
66 x 90 x 26-43½	1650 x 2250 x 661-1105	N N -RTL669024SG	9,002	9,482
66 x 84 x 26-43½	1650 x 2100 x 661-1105	N N -RTL668424SG	8,980	9,454
66 x 78 x 26-43½	1650 x 1950 x 661-1105	N N -RTL667824SG	8,960	9,431
66 x 72 x 26-43½	1650 x 1800 x 661-1105	N N -RTL667224SG	8,936	9,402

Specify the surface type (5, 6). Specify left (L) or right (R). Specify the return inside housing front finish (B, W, N). Specify metal back color (K, W).

84 x 102 x 26-43½	2100 x 2550 x 661-1105	N K -RTL8410224SG	9,559	10,111
84 x 96 x 26-43½	2100 x 2400 x 661-1105	N K -RTL849624SG	9,539	10,082
84 x 90 x 26-43½	2100 x 2250 x 661-1105	N K -RTL849024SG	9,517	10,054
84 x 84 x 26-43½	2100 x 2100 x 661-1105	N K -RTL848424SG	9,495	10,032
84 x 78 x 26-43½	2100 x 1950 x 661-1105	N K -RTL847824SG	9,473	10,005
84 x 72 x 26-43½	2100 x 1800 x 661-1105	N K -RTL847224SG	9,454	9,976
78 x 102 x 26-43½	1950 x 2550 x 661-1105	N K -RTL7810224SG	9,501	10,038
78 x 96 x 26-43½	1950 x 2400 x 661-1105	N K -RTL789624SG	9,482	10,011
78 x 90 x 26-43½	1950 x 2250 x 661-1105	N K -RTL789024SG	9,459	9,981
78 x 84 x 26-43½	1950 x 2100 x 661-1105	N K -RTL788424SG	9,439	9,962
78 x 78 x 26-43½	1950 x 1950 x 661-1105	N K -RTL787824SG	9,417	9,932
78 x 72 x 26-43½	1950 x 1800 x 661-1105	N K -RTL787224SG	9,394	9,903
72 x 102 x 26-43½	1800 x 2550 x 661-1105	N K -RTL7210224SG	9,454	9,968
72 x 96 x 26-43½	1800 x 2400 x 661-1105	N K -RTL729624SG	9,431	9,939
72 x 90 x 26-43½	1800 x 2250 x 661-1105	N K -RTL729024SG	9,410	9,910
72 x 84 x 26-43½	1800 x 2100 x 661-1105	N K -RTL728424SG	9,388	9,887
72 x 78 x 26-43½	1800 x 1950 x 661-1105	N K -RTL727824SG	9,365	9,861
72 x 72 x 26-43½	1800 x 1800 x 661-1105	N K -RTL727224SG	9,346	9,832
66 x 102 x 26-43½	1650 x 2550 x 661-1105	N K -RTL6610224SG	9,394	9,897
66 x 96 x 26-43½	1650 x 2400 x 661-1105	N K -RTL669624SG	9,374	9,869
66 x 90 x 26-43½	1650 x 2250 x 661-1105	N K -RTL669024SG	9,352	9,846
66 x 84 x 26-43½	1650 x 2100 x 661-1105	N K -RTL668424SG	9,329	9,818
66 x 78 x 26-43½	1650 x 1950 x 661-1105	N K -RTL667824SG	9,310	9,788
66 x 72 x 26-43½	1650 x 1800 x 661-1105	N K -RTL667224SG	9,288	9,759

Knife edge (K). Specify the surface type (5, 6). Specify left (L) or right (R). Specify the return inside housing front finish (B, W, N). Specify metal back color (K, W).

	W x D x H (in)	W x D x H (mm)	Code	All Laminate (\$)	HPL Surfaces (\$)
L-shaped electric height adjustable desks with 20" D return					
<i>Laminate base with metal back. Meeting space. Height adjustable from 26" to 44" H (661 to 1118 mm). Removable inside panel for wire management. Maximum weight capacity: 100 lbs (45 kg). 10' W (3048 mm) cable with cord. To add a grommet/electrical module, refer to Standardized specials on page 15.</i>					
	84 x 102 x 26-43½	2100 x 2550 x 661-1105	N_N -RTL8410220SG	9,151	9,697
	84 x 96 x 26-43½	2100 x 2400 x 661-1105	N_N -RTL849620SG	9,130	9,668
	84 x 90 x 26-43½	2100 x 2250 x 661-1105	N_N -RTL849020SG	9,116	9,638
	84 x 84 x 26-43½	2100 x 2100 x 661-1105	N_N -RTL848420SG	9,095	9,617
	84 x 78 x 26-43½	2100 x 1950 x 661-1105	N_N -RTL847820SG	9,072	9,590
	84 x 72 x 26-43½	2100 x 1800 x 661-1105	N_N -RTL847220SG	9,051	9,559
	78 x 102 x 26-43½	1950 x 2550 x 661-1105	N_N -RTL7810220SG	9,109	9,630
	78 x 96 x 26-43½	1950 x 2400 x 661-1105	N_N -RTL789620SG	9,086	9,602
	78 x 90 x 26-43½	1950 x 2250 x 661-1105	N_N -RTL789020SG	9,066	9,580
	78 x 84 x 26-43½	1950 x 2100 x 661-1105	N_N -RTL788420SG	9,043	9,552
	78 x 78 x 26-43½	1950 x 1950 x 661-1105	N_N -RTL787820SG	9,031	9,523
	78 x 72 x 26-43½	1950 x 1800 x 661-1105	N_N -RTL787220SG	9,008	9,501
	72 x 102 x 26-43½	1800 x 2550 x 661-1105	N_N -RTL7210220SG	9,066	9,567
	72 x 96 x 26-43½	1800 x 2400 x 661-1105	N_N -RTL729620SG	9,043	9,546
	72 x 90 x 26-43½	1800 x 2250 x 661-1105	N_N -RTL729020SG	9,022	9,517
	72 x 84 x 26-43½	1800 x 2100 x 661-1105	N_N -RTL728420SG	9,002	9,489
	72 x 78 x 26-43½	1800 x 1950 x 661-1105	N_N -RTL727820SG	8,980	9,466
	72 x 72 x 26-43½	1800 x 1800 x 661-1105	N_N -RTL727220SG	8,960	9,439
	66 x 102 x 26-43½	1650 x 2550 x 661-1105	N_N -RTL6610220SG	9,015	9,510
	66 x 96 x 26-43½	1650 x 2400 x 661-1105	N_N -RTL669620SG	8,993	9,482
	66 x 90 x 26-43½	1650 x 2250 x 661-1105	N_N -RTL669020SG	8,980	9,459
	66 x 84 x 26-43½	1650 x 2100 x 661-1105	N_N -RTL668420SG	8,960	9,431
	66 x 78 x 26-43½	1650 x 1950 x 661-1105	N_N -RTL667820SG	8,936	9,402
	66 x 72 x 26-43½	1650 x 1800 x 661-1105	N_N -RTL667220SG	8,914	9,382
Specify the surface type (5, 6). Specify left (L) or right (R). Specify the return inside housing front finish (B, W, N). Specify metal back color (K, W).					
	84 x 102 x 26-43½	2100 x 2550 x 661-1105	N_K -RTL8410220SG	9,510	10,061
	84 x 96 x 26-43½	2100 x 2400 x 661-1105	N_K -RTL849620SG	9,489	10,032
	84 x 90 x 26-43½	2100 x 2250 x 661-1105	N_K -RTL849020SG	9,466	10,011
	84 x 84 x 26-43½	2100 x 2100 x 661-1105	N_K -RTL848420SG	9,445	9,981
	84 x 78 x 26-43½	2100 x 1950 x 661-1105	N_K -RTL847820SG	9,422	9,954
	84 x 72 x 26-43½	2100 x 1800 x 661-1105	N_K -RTL847220SG	9,402	9,926
	78 x 102 x 26-43½	1950 x 2550 x 661-1105	N_K -RTL7810220SG	9,466	9,996
	78 x 96 x 26-43½	1950 x 2400 x 661-1105	N_K -RTL789620SG	9,445	9,976
	78 x 90 x 26-43½	1950 x 2250 x 661-1105	N_K -RTL789020SG	9,422	9,946
	78 x 84 x 26-43½	1950 x 2100 x 661-1105	N_K -RTL788420SG	9,402	9,917
	78 x 78 x 26-43½	1950 x 1950 x 661-1105	N_K -RTL787820SG	9,382	9,887
	78 x 72 x 26-43½	1950 x 1800 x 661-1105	N_K -RTL787220SG	9,359	9,861
	72 x 102 x 26-43½	1800 x 2550 x 661-1105	N_K -RTL7210220SG	9,417	9,932
	72 x 96 x 26-43½	1800 x 2400 x 661-1105	N_K -RTL729620SG	9,394	9,910
	72 x 90 x 26-43½	1800 x 2250 x 661-1105	N_K -RTL729020SG	9,374	9,882
	72 x 84 x 26-43½	1800 x 2100 x 661-1105	N_K -RTL728420SG	9,352	9,851
	72 x 78 x 26-43½	1800 x 1950 x 661-1105	N_K -RTL727820SG	9,329	9,825
	72 x 72 x 26-43½	1800 x 1800 x 661-1105	N_K -RTL727220SG	9,310	9,803
	66 x 102 x 26-43½	1650 x 2550 x 661-1105	N_K -RTL6610220SG	9,374	9,874
	66 x 96 x 26-43½	1650 x 2400 x 661-1105	N_K -RTL669620SG	9,352	9,846
	66 x 90 x 26-43½	1650 x 2250 x 661-1105	N_K -RTL669020SG	9,329	9,818
	66 x 84 x 26-43½	1650 x 2100 x 661-1105	N_K -RTL668420SG	9,310	9,788
	66 x 78 x 26-43½	1650 x 1950 x 661-1105	N_K -RTL667820SG	9,288	9,769
	66 x 72 x 26-43½	1650 x 1800 x 661-1105	N_K -RTL667220SG	9,266	9,738
Knife edge (K). Specify the surface type (5, 6). Specify left (L) or right (R). Specify the return inside housing front finish (B, W, N). Specify metal back color (K, W).					

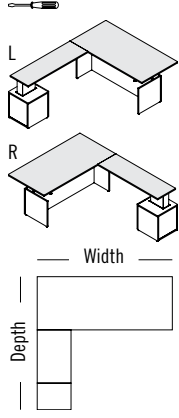

High-Gloss Black (B) or High-Gloss White (W) return inside housing front finish option: add \$122.

CAFÉ HEIGHT TABLES

Café height tables – 36" D

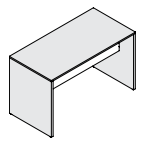

High-Gloss Black (B) or High-Gloss White (W) modesty panels finish option: 96" to 72" W (2400 to 1800 mm): add \$484; 66" to 54" W (1650 to 1350 mm): add \$323.

	W x D x H (in)	W x D x H (mm)	Code	All Laminate (\$)	HPL Surfaces (\$)
<i>18" H (457 mm) modesty panels, recessed 1¼" (309 mm) on both sides. To add a grommet/electrical module, refer to Standardized specials on page 15.</i>					
	96 x 36 x 42	2400 x 900 x 1067	N_NN -RT369642A3	2,165	2,583
	90 x 36 x 42	2250 x 900 x 1067	N_NN -RT369042A3	2,118	2,522
	84 x 36 x 42	2100 x 900 x 1067	N_NN -RT368442A3	2,074	2,463
	78 x 36 x 42	1950 x 900 x 1067	N_NN -RT367842A3	2,027	2,409
	72 x 36 x 42	1800 x 900 x 1067	N_NN -RT367242A3	1,976	2,348
	66 x 36 x 42	1650 x 900 x 1067	N_NN -RT366642A3	1,921	2,289
	60 x 36 x 42	1500 x 900 x 1067	N_NN -RT366042A3	1,876	2,234
	54 x 36 x 42	1350 x 900 x 1067	N_NN -RT365442A3	1,822	2,173
Specify the surface type (1, 2). Specify the modesty panels finish (B, W, N).					
	96 x 36 x 42	2400 x 900 x 1067	N_NN -RT369642A3	2,476	2,947
	90 x 36 x 42	2250 x 900 x 1067	N_NN -RT369042A3	2,417	2,881
	84 x 36 x 42	2100 x 900 x 1067	N_NN -RT368442A3	2,371	2,817
	78 x 36 x 42	1950 x 900 x 1067	N_NN -RT367842A3	2,318	2,756
	72 x 36 x 42	1800 x 900 x 1067	N_NN -RT367242A3	2,257	2,681
	66 x 36 x 42	1650 x 900 x 1067	N_NN -RT366642A3	2,194	2,615
	60 x 36 x 42	1500 x 900 x 1067	N_NN -RT366042A3	2,143	2,550
	54 x 36 x 42	1350 x 900 x 1067	N_NN -RT365442A3	2,088	2,485
Specify the surface type (5, 6). Specify the modesty panels finish (B, W, N).					
	96 x 36 x 42	2400 x 900 x 1067	N_KN -RT369642A3	3,100	3,686
	90 x 36 x 42	2250 x 900 x 1067	N_KN -RT369042A3	3,024	3,600
	84 x 36 x 42	2100 x 900 x 1067	N_KN -RT368442A3	2,956	3,517
	78 x 36 x 42	1950 x 900 x 1067	N_KN -RT367842A3	2,895	3,441
	72 x 36 x 42	1800 x 900 x 1067	N_KN -RT367242A3	2,817	3,358
	66 x 36 x 42	1650 x 900 x 1067	N_KN -RT366642A3	2,751	3,266
	60 x 36 x 42	1500 x 900 x 1067	N_KN -RT366042A3	2,681	3,191
	54 x 36 x 42	1350 x 900 x 1067	N_KN -RT365442A3	2,605	3,105
Knife edge (K). Specify the surface type (5, 6). Specify the modesty panels finish (B, W, N).					

Café height tables – 30" D

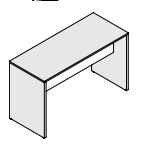

High-Gloss Black (B) or High-Gloss White (W) modesty panels finish option: 96" to 72" W (2400 to 1800 mm): add \$484; 66" to 54" W (1650 to 1350 mm): add \$323.

	W x D x H (in)	W x D x H (mm)	Code	All Laminate (\$)	HPL Surfaces (\$)
<i>18" H (457 mm) modesty panels, recessed 1¼" (281 mm) on both sides. To add a grommet/electrical module, refer to Standardized specials on page 15.</i>					
	96 x 30 x 42	2400 x 750 x 1067	N_NN -RT309642A3	2,027	2,409
	90 x 30 x 42	2250 x 750 x 1067	N_NN -RT309042A3	1,976	2,356
	84 x 30 x 42	2100 x 750 x 1067	N_NN -RT308442A3	1,936	2,300
	78 x 30 x 42	1950 x 750 x 1067	N_NN -RT307842A3	1,891	2,257
	72 x 30 x 42	1800 x 750 x 1067	N_NN -RT307242A3	1,847	2,194
	66 x 30 x 42	1650 x 750 x 1067	N_NN -RT306642A3	1,802	2,143
	60 x 30 x 42	1500 x 750 x 1067	N_NN -RT306042A3	1,758	2,088
	54 x 30 x 42	1350 x 750 x 1067	N_NN -RT305442A3	1,710	2,027
Specify the surface type (1, 2). Specify the modesty panels finish (B, W, N).					
	96 x 30 x 42	2400 x 750 x 1067	N_NN -RT309642A3	2,318	2,756
	90 x 30 x 42	2250 x 750 x 1067	N_NN -RT309042A3	2,264	2,689
	84 x 30 x 42	2100 x 750 x 1067	N_NN -RT308442A3	2,211	2,638
	78 x 30 x 42	1950 x 750 x 1067	N_NN -RT307842A3	2,165	2,574
	72 x 30 x 42	1800 x 750 x 1067	N_NN -RT307242A3	2,112	2,510
	66 x 30 x 42	1650 x 750 x 1067	N_NN -RT306642A3	2,053	2,445
	60 x 30 x 42	1500 x 750 x 1067	N_NN -RT306042A3	2,007	2,387
	54 x 30 x 42	1350 x 750 x 1067	N_NN -RT305442A3	1,953	2,325
Specify the surface type (5, 6). Specify the modesty panels finish (B, W, N).					
	96 x 30 x 42	2400 x 750 x 1067	N_KN -RT309642A3	2,895	3,441
	90 x 30 x 42	2250 x 750 x 1067	N_KN -RT309042A3	2,826	3,363
	84 x 30 x 42	2100 x 750 x 1067	N_KN -RT308442A3	2,766	3,290
	78 x 30 x 42	1950 x 750 x 1067	N_KN -RT307842A3	2,704	3,225
	72 x 30 x 42	1800 x 750 x 1067	N_KN -RT307242A3	2,638	3,138
	66 x 30 x 42	1650 x 750 x 1067	N_KN -RT306642A3	2,569	3,053
	60 x 30 x 42	1500 x 750 x 1067	N_KN -RT306042A3	2,510	2,987
	54 x 30 x 42	1350 x 750 x 1067	N_KN -RT305442A3	2,439	2,902
Knife edge (K). Specify the surface type (5, 6). Specify the modesty panels finish (B, W, N).					

Café height tables – 24" D

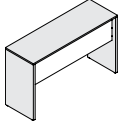

High-Gloss Black (B) or High-Gloss White (W) modesty panels finish option:
96" to 72" W (2400 to 1800 mm): add \$484;
66" to 54" W (1650 to 1350 mm): add \$323.

W x D x H (in)	W x D x H (mm)	Code	All Laminate (\$)	HPL Surfaces (\$)
<i>18" H (457 mm) modesty panels, recessed 3" (75 mm) D. To add a grommet/electrical module, refer to Standardized specials on page 15.</i>				
96 x 24 x 42	2400 x 600 x 1067	N_NN -RT249642A3	1,891	2,257
90 x 24 x 42	2250 x 600 x 1067	N_NN -RT249042A3	1,847	2,204
84 x 24 x 42	2100 x 600 x 1067	N_NN -RT248442A3	1,809	2,149
78 x 24 x 42	1950 x 600 x 1067	N_NN -RT247842A3	1,770	2,107
72 x 24 x 42	1800 x 600 x 1067	N_NN -RT247242A3	1,725	2,053
66 x 24 x 42	1650 x 600 x 1067	N_NN -RT246642A3	1,678	1,998
60 x 24 x 42	1500 x 600 x 1067	N_NN -RT246042A3	1,638	1,953
54 x 24 x 42	1350 x 600 x 1067	N_NN -RT245442A3	1,596	1,902
Specify the surface type (1, 2). Specify the modesty panel finish (B, W, N).				
96 x 24 x 42	2400 x 600 x 1067	N_NN -RT249642A3	2,165	2,574
90 x 24 x 42	2250 x 600 x 1067	N_NN -RT249042A3	2,112	2,515
84 x 24 x 42	2100 x 600 x 1067	N_NN -RT248442A3	2,064	2,463
78 x 24 x 42	1950 x 600 x 1067	N_NN -RT247842A3	2,021	2,409
72 x 24 x 42	1800 x 600 x 1067	N_NN -RT247242A3	1,968	2,348
66 x 24 x 42	1650 x 600 x 1067	N_NN -RT246642A3	1,921	2,289
60 x 24 x 42	1500 x 600 x 1067	N_NN -RT246042A3	1,876	2,234
54 x 24 x 42	1350 x 600 x 1067	N_NN -RT245442A3	1,822	2,173
Specify the surface type (5, 6). Specify the modesty panel finish (B, W, N).				
96 x 24 x 42	2400 x 600 x 1067	N_KN -RT249642A3	2,704	3,225
90 x 24 x 42	2250 x 600 x 1067	N_KN -RT249042A3	2,644	3,145
84 x 24 x 42	2100 x 600 x 1067	N_KN -RT248442A3	2,583	3,078
78 x 24 x 42	1950 x 600 x 1067	N_KN -RT247842A3	2,530	3,009
72 x 24 x 42	1800 x 600 x 1067	N_KN -RT247242A3	2,463	2,933
66 x 24 x 42	1650 x 600 x 1067	N_KN -RT246642A3	2,400	2,856
60 x 24 x 42	1500 x 600 x 1067	N_KN -RT246042A3	2,340	2,787
54 x 24 x 42	1350 x 600 x 1067	N_KN -RT245442A3	2,280	2,713
Knife edge (K). Specify the surface type (5, 6). Specify the modesty panel finish (B, W, N).				

MEETING TABLES

Meeting tables – 48" D

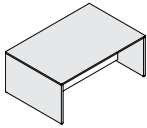

High-Gloss Black (B) or High-Gloss White (W) modesty panels finish option:
96" to 72" W (2400 to 1800 mm): add \$860;
66" to 48" W (1650 to 1200 mm): add \$571.

W x D x H (in)	W x D x H (mm)	Code	All Laminate (\$)	HPL Surfaces (\$)
<i>Modesty panels, recessed 22" H (550 mm) on both sides. To add a grommet/electrical module, refer to Standardized specials on page 15.</i>				
96 x 48 x 29½	2400 x 1200 x 752	N_NN -RC4896A	1,768	2,213
90 x 48 x 29½	2250 x 1200 x 752	N_NN -RC4890A	1,717	2,134
84 x 48 x 29½	2100 x 1200 x 752	N_NN -RC4884A	1,661	2,048
78 x 48 x 29½	1950 x 1200 x 752	N_NN -RC4878A	1,611	1,969
72 x 48 x 29½	1800 x 1200 x 752	N_NN -RC4872A	1,555	1,891
66 x 48 x 29½	1650 x 1200 x 752	N_NN -RC4866A	1,496	1,812
60 x 48 x 29½	1500 x 1200 x 752	N_NN -RC4860A	1,447	1,733
54 x 48 x 29½	1350 x 1200 x 752	N_NN -RC4854A	1,390	1,656
48 x 48 x 29½	1200 x 1200 x 752	N_NN -RC4848A	1,331	1,576
Specify the surface type (1, 2). Specify the modesty panels finish (B, W, N).				
96 x 48 x 29½	2400 x 1200 x 752	N_NN -RC4896A	1,969	2,413
90 x 48 x 29½	2250 x 1200 x 752	N_NN -RC4890A	1,899	2,320
84 x 48 x 29½	2100 x 1200 x 752	N_NN -RC4884A	1,834	2,227
78 x 48 x 29½	1950 x 1200 x 752	N_NN -RC4878A	1,768	2,134
72 x 48 x 29½	1800 x 1200 x 752	N_NN -RC4872A	1,706	2,048
66 x 48 x 29½	1650 x 1200 x 752	N_NN -RC4866A	1,633	1,954
60 x 48 x 29½	1500 x 1200 x 752	N_NN -RC4860A	1,568	1,863
54 x 48 x 29½	1350 x 1200 x 752	N_NN -RC4854A	1,504	1,768
48 x 48 x 29½	1200 x 1200 x 752	N_NN -RC4848A	1,439	1,675
Specify the surface type (5, 6). Specify the modesty panels finish (B, W, N).				
96 x 48 x 29½	2400 x 1200 x 752	N_KN -RC4896A	2,536	3,009
90 x 48 x 29½	2250 x 1200 x 752	N_KN -RC4890A	2,470	2,908
84 x 48 x 29½	2100 x 1200 x 752	N_KN -RC4884A	2,399	2,814
78 x 48 x 29½	1950 x 1200 x 752	N_KN -RC4878A	2,328	2,715
72 x 48 x 29½	1800 x 1200 x 752	N_KN -RC4872A	2,256	2,615
66 x 48 x 29½	1650 x 1200 x 752	N_KN -RC4866A	2,185	2,521
60 x 48 x 29½	1500 x 1200 x 752	N_KN -RC4860A	2,112	2,422
54 x 48 x 29½	1350 x 1200 x 752	N_KN -RC4854A	2,040	2,328
48 x 48 x 29½	1200 x 1200 x 752	N_KN -RC4848A	1,969	2,227
Knife edge (K). Specify the surface type (5, 6). Specify the modesty panels finish (B, W, N).				

Meeting tables – 42" D

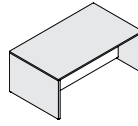

High-Gloss Black (B) or High-Gloss White (W) modesty panels finish option:
96" to 72" W (2400 to 1800 mm): add \$860;
66" to 48" W (1650 to 1200 mm): add \$571.

W x D x H (in)	W x D x H (mm)	Code	All Laminate (\$)	HPL Surfaces (\$)
<i>Modesty panels, recessed 19" H (475 mm) on both sides. To add a grommet/electrical module, refer to Standardized specials on page 15.</i>				
96 x 42 x 29½	2400 x 1050 x 752	N_NN -RC4296A	1,683	2,078
90 x 42 x 29½	2250 x 1050 x 752	N_NN -RC4290A	1,633	1,998
84 x 42 x 29½	2100 x 1050 x 752	N_NN -RC4284A	1,583	1,926
78 x 42 x 29½	1950 x 1050 x 752	N_NN -RC4278A	1,526	1,848
72 x 42 x 29½	1800 x 1050 x 752	N_NN -RC4272A	1,475	1,775
66 x 42 x 29½	1650 x 1050 x 752	N_NN -RC4266A	1,426	1,698
60 x 42 x 29½	1500 x 1050 x 752	N_NN -RC4260A	1,368	1,627
54 x 42 x 29½	1350 x 1050 x 752	N_NN -RC4254A	1,319	1,555
48 x 42 x 29½	1200 x 1050 x 752	N_NN -RC4248A	1,268	1,475
Specify the surface type (1, 2). Specify the modesty panels finish (B, W, N).				
96 x 42 x 29½	2400 x 1050 x 752	N_NN -RC4296A	1,854	2,256
90 x 42 x 29½	2250 x 1050 x 752	N_NN -RC4290A	1,798	2,168
84 x 42 x 29½	2100 x 1050 x 752	N_NN -RC4284A	1,733	2,084
78 x 42 x 29½	1950 x 1050 x 752	N_NN -RC4278A	1,669	1,998
72 x 42 x 29½	1800 x 1050 x 752	N_NN -RC4272A	1,604	1,913
66 x 42 x 29½	1650 x 1050 x 752	N_NN -RC4266A	1,546	1,826
60 x 42 x 29½	1500 x 1050 x 752	N_NN -RC4260A	1,482	1,739
54 x 42 x 29½	1350 x 1050 x 752	N_NN -RC4254A	1,419	1,656
48 x 42 x 29½	1200 x 1050 x 752	N_NN -RC4248A	1,354	1,568
Specify the surface type (5, 6). Specify the modesty panels finish (B, W, N).				
96 x 42 x 29½	2400 x 1050 x 752	N_KN -RC4296A	2,427	2,851
90 x 42 x 29½	2250 x 1050 x 752	N_KN -RC4290A	2,356	2,756
84 x 42 x 29½	2100 x 1050 x 752	N_KN -RC4284A	2,284	2,666
78 x 42 x 29½	1950 x 1050 x 752	N_KN -RC4278A	2,220	2,571
72 x 42 x 29½	1800 x 1050 x 752	N_KN -RC4272A	2,148	2,485
66 x 42 x 29½	1650 x 1050 x 752	N_KN -RC4266A	2,084	2,391
60 x 42 x 29½	1500 x 1050 x 752	N_KN -RC4260A	2,012	2,298
54 x 42 x 29½	1350 x 1050 x 752	N_KN -RC4254A	1,949	2,205
48 x 42 x 29½	1200 x 1050 x 752	N_KN -RC4248A	1,876	2,112
Knife edge (K). Specify the surface type (5, 6). Specify the modesty panels finish (B, W, N).				

Meeting tables – 36" D

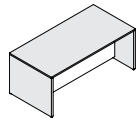

High-Gloss Black (B) or High-Gloss White (W) modesty panels finish option:
96" to 72" W (2400 to 1800 mm): add \$860;
66" to 48" W (1650 to 1200 mm): add \$571.

W x D x H (in)	W x D x H (mm)	Code	All Laminate (\$)	HPL Surfaces (\$)
<i>Modesty panels, recessed 16" H (400 mm) on both sides. To add a grommet/electrical module, refer to Standardized specials on page 15.</i>				
96 x 36 x 29½	2400 x 900 x 752	N_NN -RC3696A	1,597	1,942
90 x 36 x 29½	2250 x 900 x 752	N_NN -RC3690A	1,546	1,869
84 x 36 x 29½	2100 x 900 x 752	N_NN -RC3684A	1,496	1,798
78 x 36 x 29½	1950 x 900 x 752	N_NN -RC3678A	1,447	1,726
72 x 36 x 29½	1800 x 900 x 752	N_NN -RC3672A	1,396	1,661
66 x 36 x 29½	1650 x 900 x 752	N_NN -RC3666A	1,346	1,588
60 x 36 x 29½	1500 x 900 x 752	N_NN -RC3660A	1,296	1,519
54 x 36 x 29½	1350 x 900 x 752	N_NN -RC3654A	1,247	1,447
48 x 36 x 29½	1200 x 900 x 752	N_NN -RC3648A	1,196	1,382
Specify the surface type (1, 2). Specify the modesty panels finish (B, W, N).				
96 x 36 x 29½	2400 x 900 x 752	N_NN -RC3696A	1,747	2,090
90 x 36 x 29½	2250 x 900 x 752	N_NN -RC3690A	1,689	2,012
84 x 36 x 29½	2100 x 900 x 752	N_NN -RC3684A	1,633	1,934
78 x 36 x 29½	1950 x 900 x 752	N_NN -RC3678A	1,568	1,854
72 x 36 x 29½	1800 x 900 x 752	N_NN -RC3672A	1,511	1,775
66 x 36 x 29½	1650 x 900 x 752	N_NN -RC3666A	1,453	1,698
60 x 36 x 29½	1500 x 900 x 752	N_NN -RC3660A	1,390	1,620
54 x 36 x 29½	1350 x 900 x 752	N_NN -RC3654A	1,331	1,539
48 x 36 x 29½	1200 x 900 x 752	N_NN -RC3648A	1,275	1,462
Specify the surface type (5, 6). Specify the modesty panels finish (B, W, N).				
96 x 36 x 29½	2400 x 900 x 752	N_KN -RC3696A	2,314	2,693
90 x 36 x 29½	2250 x 900 x 752	N_KN -RC3690A	2,241	2,607
84 x 36 x 29½	2100 x 900 x 752	N_KN -RC3684A	2,179	2,521
78 x 36 x 29½	1950 x 900 x 752	N_KN -RC3678A	2,112	2,436
72 x 36 x 29½	1800 x 900 x 752	N_KN -RC3672A	2,048	2,349
66 x 36 x 29½	1650 x 900 x 752	N_KN -RC3666A	1,984	2,256
60 x 36 x 29½	1500 x 900 x 752	N_KN -RC3660A	1,918	2,168
54 x 36 x 29½	1350 x 900 x 752	N_KN -RC3654A	1,854	2,084
48 x 36 x 29½	1200 x 900 x 752	N_KN -RC3648A	1,792	1,998
Knife edge (K). Specify the surface type (5, 6). Specify the modesty panels finish (B, W, N).				

W x D x H (in) W x D x H (mm) Code All Laminate (\$) HPL Surfaces (\$)

COMPLEMENTARY FURNITURE

Console tables

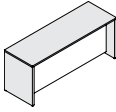

High-Gloss Black (B) or High-Gloss White (W) backs finish option: 96" to 72" W (2400 to 1800 mm): add \$860; 66" to 48" W (1650 to 1200 mm): add \$571.

7" (175 mm) recessed back on both sides. To add a grommet/electrical module, refer to Standardized specials on page 15.

Table with columns: W x D x H (in), W x D x H (mm), Code, All Laminate (\$), HPL Surfaces (\$). Rows include 96 x 18 x 29 1/2, 90 x 18 x 29 1/2, 84 x 18 x 29 1/2, 78 x 18 x 29 1/2, 72 x 18 x 29 1/2, 66 x 18 x 29 1/2, 60 x 18 x 29 1/2, 54 x 18 x 29 1/2, 48 x 18 x 29 1/2.

Specify the surface type (1, 2). Specify the backs finish (B, W, N).

Table with columns: W x D x H (in), W x D x H (mm), Code, All Laminate (\$), HPL Surfaces (\$). Rows include 96 x 18 x 29 1/2, 90 x 18 x 29 1/2, 84 x 18 x 29 1/2, 78 x 18 x 29 1/2, 72 x 18 x 29 1/2, 66 x 18 x 29 1/2, 60 x 18 x 29 1/2, 54 x 18 x 29 1/2, 48 x 18 x 29 1/2.

Specify the surface type (5, 6). Specify the backs finish (B, W, N).

Table with columns: W x D x H (in), W x D x H (mm), Code, All Laminate (\$), HPL Surfaces (\$). Rows include 96 x 18 x 29 1/2, 90 x 18 x 29 1/2, 84 x 18 x 29 1/2, 78 x 18 x 29 1/2, 72 x 18 x 29 1/2, 66 x 18 x 29 1/2, 60 x 18 x 29 1/2, 54 x 18 x 29 1/2, 48 x 18 x 29 1/2.

Knife edge (K). Specify the surface type (5, 6). Specify the backs finish (B, W, N).

Magazine tables



High-Gloss Black (B) or High-Gloss White (W) backs finish option: add \$122.

To add a grommet/electrical module, refer to Standardized specials on page 15.

Table with columns: W x D x H (in), W x D x H (mm), Code, All Laminate (\$), HPL Surfaces (\$). Rows include 60 x 24 x 14, 48 x 24 x 14.

Specify the surface type (1, 2). Specify the backs finish (B, W, N).

Table with columns: W x D x H (in), W x D x H (mm), Code, All Laminate (\$), HPL Surfaces (\$). Rows include 60 x 24 x 14, 48 x 24 x 14.

Specify the surface type (5, 6). Specify the backs finish (B, W, N).

Table with columns: W x D x H (in), W x D x H (mm), Code, All Laminate (\$), HPL Surfaces (\$). Rows include 60 x 24 x 14, 48 x 24 x 14.

Knife edge (K). Specify the surface type (5, 6). Specify the backs finish (B, W, N).

Coffee tables



High-Gloss Black (B) or High-Gloss White (W) backs finish option: add \$122.

To add a grommet/electrical module, refer to Standardized specials on page 15.

Table with columns: W x D x H (in), W x D x H (mm), Code, All Laminate (\$), HPL Surfaces (\$). Rows include 30 x 30 x 18, 24 x 24 x 18.

Specify the surface type (1, 2). Specify the backs finish (B, W, N).

Table with columns: W x D x H (in), W x D x H (mm), Code, All Laminate (\$), HPL Surfaces (\$). Rows include 30 x 30 x 18, 24 x 24 x 18.

Specify the surface type (5, 6). Specify the backs finish (B, W, N).

Table with columns: W x D x H (in), W x D x H (mm), Code, All Laminate (\$), HPL Surfaces (\$). Rows include 30 x 30 x 18, 24 x 24 x 18.

Knife edge (K). Specify the surface type (5, 6). Specify the backs finish (B, W, N).

Benches

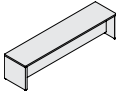

High-Gloss Black (B) or High-Gloss White (W) backs finish option: add \$122.

7" (175 mm) recessed back on both sides. To add a grommet/electrical module, refer to Standardized specials on page 15. 1 tone only. Can accommodate cushions.

Table with columns: W x D x H (in), W x D x H (mm), Code, All Laminate (\$), HPL Surfaces (\$). Rows include 96 x 18 x 18, 90 x 18 x 18, 84 x 18 x 18, 78 x 18 x 18, 72 x 18 x 18, 66 x 18 x 18, 60 x 18 x 18, 54 x 18 x 18, 48 x 18 x 18.

Specify the surface type (1, 2).

W x D x H (in) W x D x H (mm) Code All Laminate (\$) HPL Surfaces (\$)

Benches (cont'd)

Table with columns: W x D x H (in), W x D x H (mm), Code, All Laminate (\$), HPL Surfaces (\$). Rows include 96 x 18 x 18, 90 x 18 x 18, 84 x 18 x 18, 78 x 18 x 18, 72 x 18 x 18, 66 x 18 x 18, 60 x 18 x 18, 54 x 18 x 18, 48 x 18 x 18.

Specify the surface type (5, 6).

Table with columns: W x D x H (in), W x D x H (mm), Code, All Laminate (\$), HPL Surfaces (\$). Rows include 96 x 18 x 18, 90 x 18 x 18, 84 x 18 x 18, 78 x 18 x 18, 72 x 18 x 18, 66 x 18 x 18, 60 x 18 x 18, 54 x 18 x 18, 48 x 18 x 18.

Knife edge (K). Specify the surface type (5, 6).

STORAGE MODULES — 21" H

Storage modules with drawers — 21" H



High-Gloss Black (B) or High-Gloss White (W) fronts finish option: add \$81.

1 box drawer and 1 file drawer with soft-close. No soft-close mechanism on 24" (600 mm) wide file drawer. Suspension bar. Pencil tray. Lock. Can accommodate 1 cushion.

Table with columns: W x D x H (in), W x D x H (mm), Code, All Laminate (\$), HPL Surfaces (\$). Rows include 24 x 36 x 21, 16 x 36 x 21, 24 x 30 x 21, 16 x 30 x 21, 24 x 24 x 21, 16 x 24 x 21, 24 x 20 x 21, 16 x 20 x 21.

Specify the surface type (1, 2). Specify the handle curve: double (D), left (L) or right (R). Specify the fronts finish (B, W, N).

Storage modules with drawers — 21" H



High-Gloss Black (B) or High-Gloss White (W) fronts finish option: add \$122.

1 box drawer with soft-close and 1 file drawer with suspension bar. Pencil tray. Lock. Can accommodate 1 cushion.

Table with columns: W x D x H (in), W x D x H (mm), Code, All Laminate (\$), HPL Surfaces (\$). Rows include 36 x 36 x 21, 30 x 36 x 21, 36 x 30 x 21, 30 x 30 x 21, 36 x 24 x 21, 30 x 24 x 21, 36 x 20 x 21, 30 x 20 x 21.

Specify the surface type (1, 2). Specify the handle curve: double (D), left (L) or right (R). Specify the fronts finish (B, W, N).

Storage modules with drawers on left, hidden space on right — 21" H



High-Gloss Black (B) or High-Gloss White (W) fronts finish option: add \$160.

1 box drawer with soft-close and 1 file drawer with suspension bar. Pencil tray. Lock. 12" W (284 mm) hidden space on right. Can accommodate 1 cushion.

Table with columns: W x D x H (in), W x D x H (mm), Code, All Laminate (\$), HPL Surfaces (\$). Rows include 48 x 36 x 21, 42 x 36 x 21, 48 x 30 x 21, 42 x 30 x 21, 48 x 24 x 21, 42 x 24 x 21, 48 x 20 x 21, 42 x 20 x 21.

Specify the surface type (1, 2). Specify the handle curve: double (D), left (L) or right (R). Specify the fronts finish (B, W, N).

Storage modules with drawers on right, hidden space on left — 21" H



High-Gloss Black (B) or High-Gloss White (W) fronts finish option: add \$160.

1 box drawer with soft-close and 1 file drawer with suspension bar. Pencil tray. Lock. 12" W (284 mm) hidden space on left. Can accommodate 1 cushion.

Table with columns: W x D x H (in), W x D x H (mm), Code, All Laminate (\$), HPL Surfaces (\$). Rows include 48 x 36 x 21, 42 x 36 x 21, 48 x 30 x 21, 42 x 30 x 21, 48 x 24 x 21, 42 x 24 x 21, 48 x 20 x 21, 42 x 20 x 21.

Specify the surface type (1, 2). Specify the handle curve: double (D), left (L) or right (R). Specify the fronts finish (B, W, N).

W x D x H (in)	W x D x H (mm)	Code	All Laminate (\$)	HPL Surfaces (\$)
Storage modules with drawers on left, open bookcase on right – 21" H				
<i>1 box drawer and 1 file drawer with soft-close. Suspension bar. Pencil tray. Lock. Open bookcase without back on right. Can accommodate 1 cushion.</i>				
48 x 24 x 21	1200 x 619 x 561	N_N_-F244821BE	1,988	2,144
42 x 24 x 21	1050 x 619 x 561	N_N_-F244221BE	1,950	2,081
36 x 24 x 21	900 x 619 x 561	N_N_-F243621BE	1,892	2,022
30 x 24 x 21	750 x 619 x 561	N_N_-F243021BE	1,854	1,950
48 x 20 x 21	1200 x 519 x 561	N_N_-F204821BE	1,934	2,062
42 x 20 x 21	1050 x 519 x 561	N_N_-F204221BE	1,892	2,008
36 x 20 x 21	900 x 519 x 561	N_N_-F203621BE	1,863	1,959
30 x 20 x 21	750 x 519 x 561	N_N_-F203021BE	1,829	1,910
Specify the surface type (1, 2). Specify the handle curve: right (R) or double (D). Specify the fronts finish (B, W, N).				



High-Gloss Black (B) or High-Gloss White (W) fronts finish option: add \$81.

W x D x H (in)	W x D x H (mm)	Code	All Laminate (\$)	HPL Surfaces (\$)
Storage modules with drawers on right, open bookcase on left – 21" H				
<i>1 box drawer and 1 file drawer with soft-close. Suspension bar. Pencil tray. Lock. Open bookcase without back on left. Can accommodate 1 cushion.</i>				
48 x 24 x 21	1200 x 619 x 561	N_N_-BE244821F	1,988	2,144
42 x 24 x 21	1050 x 619 x 561	N_N_-BE244221F	1,950	2,081
36 x 24 x 21	900 x 619 x 561	N_N_-BE243621F	1,892	2,022
30 x 24 x 21	750 x 619 x 561	N_N_-BE243021F	1,854	1,950
48 x 20 x 21	1200 x 519 x 561	N_N_-BE204821F	1,934	2,062
42 x 20 x 21	1050 x 519 x 561	N_N_-BE204221F	1,892	2,008
36 x 20 x 21	900 x 519 x 561	N_N_-BE203621F	1,863	1,959
30 x 20 x 21	750 x 519 x 561	N_N_-BE203021F	1,829	1,910
Specify the surface type (1, 2). Specify the handle curve: left (L) or double (D). Specify the fronts finish (B, W, N).				



High-Gloss Black (B) or High-Gloss White (W) fronts finish option: add \$81.

W x D x H (in)	W x D x H (mm)	Code	All Laminate (\$)	HPL Surfaces (\$)
Storage modules with drawers on left, CPU storage on right – 21" H				
<i>1 box drawer and 1 file drawer with soft-close. Suspension bar. Pencil tray. Lock. Open CPU storage on right. Grommets on the surface and on the side of CPU storage. Can accommodate 1 cushion. CPU space: 7 1/2" W (193 mm).</i>				
24 x 36 x 21	600 x 919 x 561	N_N_-F362421CPU	1,780	1,892
24 x 30 x 21	600 x 769 x 561	N_N_-F302421CPU	1,732	1,829
24 x 24 x 21	600 x 619 x 561	N_N_-F242421CPU	1,676	1,760
Specify the surface type (1, 2). Specify the handle curve: right (R) or double (D). Specify the fronts finish (B, W, N).				



High-Gloss Black (B) or High-Gloss White (W) front finish option: add \$81.

W x D x H (in)	W x D x H (mm)	Code	All Laminate (\$)	HPL Surfaces (\$)
Storage modules with drawers on right, CPU storage on left – 21" H				
<i>1 box drawer and 1 file drawer with soft-close. Suspension bar. Pencil tray. Lock. Open CPU storage on left. Grommets on the surface and on the side of CPU storage. Can accommodate 1 cushion. CPU space: 7 1/2" W (193 mm).</i>				
24 x 36 x 21	600 x 919 x 561	N_N_-CPU362421F	1,780	1,892
24 x 30 x 21	600 x 769 x 561	N_N_-CPU302421F	1,732	1,829
24 x 24 x 21	600 x 619 x 561	N_N_-CPU242421F	1,676	1,760
Specify the surface type (1, 2). Specify the handle curve: left (L) or double (D). Specify the fronts finish (B, W, N).				



High-Gloss Black (B) or High-Gloss White (W) fronts finish option: add \$81.

W x D x H (in)	W x D x H (mm)	Code	All Laminate (\$)	HPL Surfaces (\$)
Storage modules with drawers on left, CPU storage on right – 21" H				
<i>1 box drawer with soft-close and 1 file drawer with suspension bar. Pencil tray. Lock. Open CPU storage on right. Grommets on the surface and on the side of CPU storage. Can accommodate 1 cushion. CPU space: 12" W (300 mm).</i>				
36 x 36 x 21	900 x 919 x 561	N_N_-UL363621CPU	1,926	2,111
36 x 30 x 21	900 x 769 x 561	N_N_-UL303621CPU	1,863	2,008
36 x 24 x 21	900 x 619 x 561	N_N_-UL243621CPU	1,806	1,918
Specify the surface type (1, 2). Specify the handle curve: right (R) or double (D). Specify the fronts finish (B, W, N).				



High-Gloss Black (B) or High-Gloss White (W) fronts finish option: add \$122.

W x D x H (in)	W x D x H (mm)	Code	All Laminate (\$)	HPL Surfaces (\$)
Storage modules with drawers on right, CPU storage on left – 21" H				
<i>1 box drawer with soft-close and 1 file drawer with suspension bar. Pencil tray. Lock. Open CPU storage on left. Grommets on the surface and on the side of CPU storage. Can accommodate 1 cushion. CPU space: 12" W (300 mm).</i>				
36 x 36 x 21	900 x 919 x 561	N_N_-CPU363621UL	1,926	2,111
36 x 30 x 21	900 x 769 x 561	N_N_-CPU303621UL	1,863	2,008
36 x 24 x 21	900 x 619 x 561	N_N_-CPU243621UL	1,806	1,918
Specify the surface type (1, 2). Specify the handle curve: left (L) or double (D). Specify the fronts finish (B, W, N).				



High-Gloss Black (B) or High-Gloss White (W) fronts finish option: add \$122.

W x D x H (in)	W x D x H (mm)	Code	All Laminate (\$)	HPL Surfaces (\$)
Storage modules with doors – 21" H				
<i>2 doors with soft-close. Lock. Can accommodate 1 cushion.</i>				
36 x 36 x 21	900 x 919 x 561	N_NN_-363621B	1,950	2,095
30 x 36 x 21	750 x 919 x 561	N_NN_-363021B	1,863	1,988
36 x 30 x 21	900 x 769 x 561	N_NN_-303621B	1,877	2,022
30 x 30 x 21	750 x 769 x 561	N_NN_-303021B	1,814	1,926
48 x 24 x 21	1200 x 619 x 561	N_NN_-244821B	1,806	1,936
42 x 24 x 21	1050 x 619 x 561	N_NN_-244221B	1,738	1,869
36 x 24 x 21	900 x 619 x 561	N_NN_-243621B	1,676	1,786
30 x 24 x 21	750 x 619 x 561	N_NN_-243021B	1,628	1,725
48 x 20 x 21	1200 x 519 x 561	N_NN_-204821B	1,760	1,879
42 x 20 x 21	1050 x 519 x 561	N_NN_-204221B	1,690	1,814
36 x 20 x 21	900 x 519 x 561	N_NN_-203621B	1,621	1,716
30 x 20 x 21	750 x 519 x 561	N_NN_-203021B	1,564	1,654
Specify the surface type (1, 2). Specify the fronts finish (B, W, N).				



High-Gloss Black (B) or High-Gloss White (W) fronts finish option: add \$160.
48" to 42" W (1200 to 1050 mm): 2 adjustable shelves;
36" to 30" W (900 to 750 mm): 1 adjustable shelf.

W x D x H (in)	W x D x H (mm)	Code	All Laminate (\$)	HPL Surfaces (\$)
Storage modules with door – 21" H				
<i>1 door with soft-close. Lock. 1 adjustable shelf. Can accommodate 1 cushion.</i>				
24 x 36 x 21	600 x 919 x 561	N_NN_-362421B	1,426	1,538
16 x 36 x 21	409 x 919 x 561	N_NN_-361621B	1,322	1,395
24 x 30 x 21	600 x 769 x 561	N_NN_-302421B	1,384	1,482
16 x 30 x 21	409 x 769 x 561	N_NN_-301621B	1,289	1,345
24 x 24 x 21	600 x 619 x 561	N_NN_-242421B	1,335	1,419
16 x 24 x 21	409 x 619 x 561	N_NN_-241621B	1,256	1,306
24 x 20 x 21	600 x 519 x 561	N_NN_-202421B	1,298	1,371
16 x 20 x 21	409 x 519 x 561	N_NN_-201621B	1,219	1,264
Specify the surface type (1, 2). Specify the handle curve: left (L) or Right (R). Specify the front finish (B, W, N).				



High-Gloss Black (B) or High-Gloss White (W) front finish option: add \$81.

W x D x H (in)	W x D x H (mm)	Code	All Laminate (\$)	HPL Surfaces (\$)
Storage modules with door on left, open bookcase on right – 21" H				
<i>1 door with soft-close. Lock. 1 adjustable shelf. Open bookcase without back on right. Hinges on right. Can accommodate 1 cushion.</i>				
48 x 24 x 21	1200 x 619 x 561	N_NN_-B244821BE	1,530	1,676
42 x 24 x 21	1050 x 619 x 561	N_NN_-B244221BE	1,490	1,628
36 x 24 x 21	900 x 619 x 561	N_NN_-B243621BE	1,452	1,564
30 x 24 x 21	750 x 619 x 561	N_NN_-B243021BE	1,419	1,518
48 x 20 x 21	1200 x 519 x 561	N_NN_-B204821BE	1,459	1,597
42 x 20 x 21	1050 x 519 x 561	N_NN_-B204221BE	1,445	1,557
36 x 20 x 21	900 x 519 x 561	N_NN_-B203621BE	1,419	1,518
30 x 20 x 21	750 x 519 x 561	N_NN_-B203021BE	1,402	1,482
Specify the surface type (1, 2). Specify the handle curve: right (R) or double (D). Specify the front finish (B, W, N).				



High-Gloss Black (B) or High-Gloss White (W) front finish option: add \$81.

W x D x H (in)	W x D x H (mm)	Code	All Laminate (\$)	HPL Surfaces (\$)
Storage modules with door on right, open bookcase on left – 21" H				
<i>1 door with soft-close. Lock. 1 adjustable shelf. Open bookcase without back on left. Hinges on left. Can accommodate 1 cushion.</i>				
48 x 24 x 21	1200 x 619 x 561	N_NN_-BE244821B	1,530	1,676
42 x 24 x 21	1050 x 619 x 561	N_NN_-BE244221B	1,490	1,628
36 x 24 x 21	900 x 619 x 561	N_NN_-BE243621B	1,452	1,564
30 x 24 x 21	750 x 619 x 561	N_NN_-BE243021B	1,419	1,518
48 x 20 x 21	1200 x 519 x 561	N_NN_-BE204821B	1,459	1,597
42 x 20 x 21	1050 x 519 x 561	N_NN_-BE204221B	1,445	1,557
36 x 20 x 21	900 x 519 x 561	N_NN_-BE203621B	1,419	1,518
30 x 20 x 21	750 x 519 x 561	N_NN_-BE203021B	1,402	1,482
Specify the surface type (1, 2). Specify the handle curve: left (L) or double (D). Specify the front finish (B, W, N).				



High-Gloss Black (B) or High-Gloss White (W) front finish option: add \$81.

W x D x H (in)	W x D x H (mm)	Code	All Laminate (\$)	HPL Surfaces (\$)
Storage modules with drawers on left, open bookcase on right – 21" H				
<i>1 box drawer with soft-close and 1 file drawer with suspension bar. Pencil tray. Lock. Open bookcase without back on right. Can accommodate 1 or 2 cushions.</i>				
72 x 20 x 21	1800 x 519 x 561	N_NN_-UL207221BE	2,106	2,281
60 x 20 x 21	1500 x 519 x 561	N_NN_-UL206021BE	1,983	2,144
Specify the surface type (1, 2). Specify the handle curve: right (R) or double (D). Specify the fronts finish (B, W, N).				

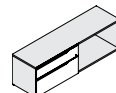

High-Gloss Black (B) or High-Gloss White (W) fronts finish option: add \$160.

W x D x H (in)	W x D x H (mm)	Code	All Laminate (\$)	HPL Surfaces (\$)
Storage modules with drawers on right, open bookcase on left – 21" H				
<i>1 box drawer with soft-close and 1 file drawer with suspension bar. Pencil tray. Lock. Open bookcase without back on left. Can accommodate 1 or 2 cushions.</i>				
72 x 20 x 21	1800 x 519 x 561	N_N_-BE207221UL	2,106	2,281
60 x 20 x 21	1500 x 519 x 561	N_N_-BE206021UL	1,983	2,144

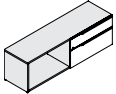

High-Gloss Black (B) or High-Gloss White (W) fronts finish option: add \$160.

W x D x H (in)	W x D x H (mm)	Code	All Laminate (\$)	HPL Surfaces (\$)
Storage modules with drawers on left, hidden space on right, open bookcase on right – 21" H				
<i>1 box drawer with soft-close and 1 file drawer with suspension bar. Pencil tray. Lock. 12" W (284 mm) hidden space on right. Open bookcase without back on right. Can accommodate 1 or 2 cushions.</i>				
96 x 20 x 21	2400 x 519 x 561	N_N_-ULS209621BE	2,614	2,860
90 x 20 x 21	2250 x 519 x 561	N_N_-ULS209021BE	2,586	2,829
84 x 20 x 21	2100 x 519 x 561	N_N_-ULS208421BE	2,442	2,662
78 x 20 x 21	1950 x 519 x 561	N_N_-ULS207821BE	2,410	2,620
72 x 20 x 21	1800 x 519 x 561	N_N_-ULS207221BE	2,344	2,531

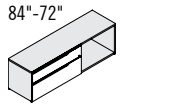
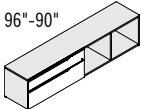

High-Gloss Black (B) or High-Gloss White (W) fronts finish option: add \$160.

W x D x H (in)	W x D x H (mm)	Code	All Laminate (\$)	HPL Surfaces (\$)
Storage modules with drawers on right, hidden space on left, open bookcase on left – 21" H				
<i>1 box drawer with soft-close and 1 file drawer with suspension bar. Pencil tray. Lock. 12" W (284 mm) hidden space on left. Open bookcase without back on left. Can accommodate 1 or 2 cushions.</i>				
96 x 20 x 21	2400 x 519 x 561	N_N_-BE209621ULS	2,614	2,860
90 x 20 x 21	2250 x 519 x 561	N_N_-BE209021ULS	2,586	2,829
84 x 20 x 21	2100 x 519 x 561	N_N_-BE208421ULS	2,442	2,662
78 x 20 x 21	1950 x 519 x 561	N_N_-BE207821ULS	2,410	2,620
72 x 20 x 21	1800 x 519 x 561	N_N_-BE207221ULS	2,344	2,531

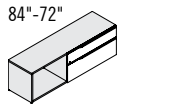
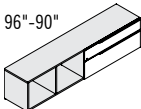

High-Gloss Black (B) or High-Gloss White (W) fronts finish option: add \$160.

W x D x H (in)	W x D x H (mm)	Code	All Laminate (\$)	HPL Surfaces (\$)
Double storage modules with drawers – 21" H				
<i>2 box drawers with soft-close and 2 file drawers with suspension bars. Pencil tray. Locks. Can accommodate 1 or 2 cushions.</i>				
72 x 20 x 21	1800 x 519 x 561	N_NN_-UL207221UL	3,152	3,337
60 x 20 x 21	1500 x 519 x 561	N_NN_-UL206021UL	3,070	3,337

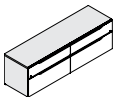

High-Gloss Black (B) or High-Gloss White (W) fronts finish option: add \$242.

W x D x H (in)	W x D x H (mm)	Code	All Laminate (\$)	HPL Surfaces (\$)
Double storage modules with drawers, hidden spaces on right and left – 21" H				
<i>2 box drawers with soft-close and 2 file drawers with suspension bars. Pencil tray. Locks. Left and right hidden spaces. Can accommodate 1 or 2 cushions.</i>				
<i>96" W (2400 mm): hidden space of 12" W (297 mm);</i>				
<i>90" W (2250 mm): hidden space of 9" W (222 mm);</i>				
<i>84" W (2100 mm): hidden space of 12" W (297 mm);</i>				
<i>78" W (1950 mm): hidden space of 9" W (222 mm);</i>				
<i>72" W (1800 mm): hidden space of 12" W (297 mm).</i>				
96 x 20 x 21	2400 x 519 x 561	N_NN_-ULS209621ULS	3,740	3,989
90 x 20 x 21	2250 x 519 x 561	N_NN_-ULS209021ULS	3,674	3,906
84 x 20 x 21	2100 x 519 x 561	N_NN_-ULS208421ULS	3,612	3,820
78 x 20 x 21	1950 x 519 x 561	N_NN_-ULS207821ULS	3,545	3,733
72 x 20 x 21	1800 x 519 x 561	N_NN_-ULS207221ULS	3,475	3,659

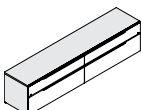

High-Gloss Black (B) or High-Gloss White (W) fronts finish option: add \$323.

W x D x H (in)	W x D x H (mm)	Code	All Laminate (\$)	HPL Surfaces (\$)
Storage modules with doors on left, open bookcase on right – 21" H				
<i>2 doors with soft-close. Lock. Open bookcase without back on right. Can accommodate 1 or 2 cushions.</i>				
<i>96" to 84" W (2400 to 2100 mm): 2 adjustable shelves;</i>				
<i>78" to 60" W (1950 to 1500 mm): 1 adjustable shelf.</i>				
96" x 20 x 21	2400 x 519 x 561	N_NN_-B209621BE	2,095	2,351
90" x 20 x 21	2250 x 519 x 561	N_NN_-B209021BE	2,047	2,281
84" x 20 x 21	2100 x 519 x 561	N_NN_-B208421BE	1,988	2,210
78" x 20 x 21	1950 x 519 x 561	N_NN_-B207821BE	1,760	1,942
72" x 20 x 21	1800 x 519 x 561	N_NN_-B207221BE	1,676	1,869
66" x 20 x 21	1650 x 519 x 561	N_NN_-B206621BE	1,628	1,786
60" x 20 x 21	1500 x 519 x 561	N_NN_-B206021BE	1,564	1,725

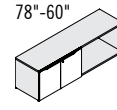
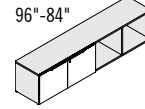

High-Gloss Black (B) or High-Gloss White (W) fronts finish option: add \$160.

W x D x H (in)	W x D x H (mm)	Code	All Laminate (\$)	HPL Surfaces (\$)
Storage modules with doors on right, open bookcase on left – 21" H				
<i>2 doors with soft-close. Lock. Open bookcase without back on left. Can accommodate 1 or 2 cushions.</i>				
<i>96" to 84" W (2400 to 2100 mm): 2 adjustable shelves;</i>				
<i>78" to 60" W (1950 to 1500 mm): 1 adjustable shelf.</i>				
96" x 20 x 21	2400 x 519 x 561	N_NN_-BE209621B	2,095	2,351
90" x 20 x 21	2250 x 519 x 561	N_NN_-BE209021B	2,047	2,281
84" x 20 x 21	2100 x 519 x 561	N_NN_-BE208421B	1,988	2,210
78" x 20 x 21	1950 x 519 x 561	N_NN_-BE207821B	1,760	1,942
72" x 20 x 21	1800 x 519 x 561	N_NN_-BE207221B	1,676	1,869
66" x 20 x 21	1650 x 519 x 561	N_NN_-BE206621B	1,628	1,786
60" x 20 x 21	1500 x 519 x 561	N_NN_-BE206021B	1,564	1,725

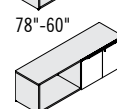
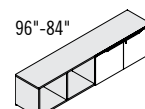

High-Gloss Black (B) or High-Gloss White (W) fronts finish option: add \$160.

W x D x H (in)	W x D x H (mm)	Code	All Laminate (\$)	HPL Surfaces (\$)
Double storage modules with doors – 21" H				
<i>4 doors with soft-close. Locks. Can accommodate 1 or 2 cushions.</i>				
<i>96" to 84" W (2400 to 2100 mm): 4 adjustable shelves;</i>				
<i>78" to 60" W (1950 to 1500 mm): 2 adjustable shelves.</i>				
96" x 20 x 21	2400 x 519 x 561	N_NN_-B209621B	2,812	3,063
90" x 20 x 21	2250 x 519 x 561	N_NN_-B209021B	2,749	2,997
84" x 20 x 21	2100 x 519 x 561	N_NN_-B208421B	2,701	2,926
78" x 20 x 21	1950 x 519 x 561	N_NN_-B207821B	2,401	2,614
72" x 20 x 21	1800 x 519 x 561	N_NN_-B207221B	2,351	2,539
66" x 20 x 21	1650 x 519 x 561	N_NN_-B206621B	2,305	2,491
60" x 20 x 21	1500 x 519 x 561	N_NN_-B206021B	2,241	2,401

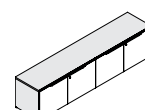

High-Gloss Black (B) or High-Gloss White (W) fronts finish option: add \$323.

W x D x H (in)	W x D x H (mm)	Code	All Laminate (\$)	HPL Surfaces (\$)
Storage modules with drawers on left and doors on right – 21" H				
<i>1 box drawer with soft-close and 1 file drawer with suspension bar on left. Pencil tray. Locks. 2 doors with soft-close on right. 1 adjustable shelf. Can accommodate 1 or 2 cushions.</i>				
72" x 20 x 21	1800 x 519 x 561	N_N_-UL207221B	2,627	2,819
60" x 20 x 21	1500 x 519 x 561	N_N_-UL206021B	2,514	2,676

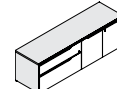

High-Gloss Black (B) or High-Gloss White (W) fronts finish option: add \$242.

W x D x H (in)	W x D x H (mm)	Code	All Laminate (\$)	HPL Surfaces (\$)
Storage modules with drawers on right and doors on left – 21" H				
<i>1 box drawer with soft-close and 1 file drawer with suspension bar on right. Pencil tray. Locks. 2 doors with soft-close on left. 1 adjustable shelf. Can accommodate 1 or 2 cushions.</i>				
72" x 20 x 21	1800 x 519 x 561	N_N_-B207221UL	2,627	2,819
60" x 20 x 21	1500 x 519 x 561	N_N_-B206021UL	2,514	2,676

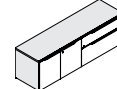

High-Gloss Black (B) or High-Gloss White (W) fronts finish option: add \$242.

2-TONE LAMINATE APPLICATION: SHADED AREA CORRESPONDS TO THE FIRST CODE TO BE SPECIFIED. SECOND LAMINATE CODE WILL BE APPLIED TO THE REST OF THE PRODUCT.

W x D x H (in)	W x D x H (mm)	Code	All Laminate (\$)	HPL Surfaces (\$)
Storage modules with drawers on left, hidden space on right, doors on right – 21" H				
<i>1 box drawer with soft-close and 1 file drawer with suspension bar on left. Pencil tray. Locks. 12" W (299 mm) right hidden space. 2 doors with soft-close on right. Can accommodate 1 or 2 cushions. 96" to 90" W (2400 to 2250 mm): 2 adjustable shelves; 84" to 78" W (2100 to 1950 mm): 1 adjustable shelf.</i>				
96"-90"	96 x 20 x 21	2400 x 519 x 561	N_N_-ULS209621B	3,233 3,481
	90 x 20 x 21	2250 x 519 x 561	N_N_-ULS209021B	3,177 3,416
	84 x 20 x 21	2100 x 519 x 561	N_N_-ULS208421B	2,943 3,157
	78 x 20 x 21	1950 x 519 x 561	N_N_-ULS207821B	2,878 3,089
Specify the surface type (1, 2). Specify the handle curve: right (R) or double (D). Specify the fronts finish (B, W, N).				

High-Gloss Black (B) or High-Gloss White (W) fronts finish option: add \$323.

W x D x H (in)	W x D x H (mm)	Code	All Laminate (\$)	HPL Surfaces (\$)
Storage modules with drawers on right, hidden space on left, doors on left – 21" H				
<i>1 box drawer with soft-close and 1 file drawer with suspension bar on right. Pencil tray. Locks. 12" W (299 mm) left hidden space. 2 doors with soft-close on left. Can accommodate 1 or 2 cushions. 96" to 90" W (2400 to 2250 mm): 2 adjustable shelves; 84" to 78" W (2100 to 1950 mm): 1 adjustable shelf.</i>				
96"-90"	96 x 20 x 21	2400 x 519 x 561	N_N_-B209621ULS	3,233 3,481
	90 x 20 x 21	2250 x 519 x 561	N_N_-B209021ULS	3,177 3,416
	84 x 20 x 21	2100 x 519 x 561	N_N_-B208421ULS	2,943 3,157
	78 x 20 x 21	1950 x 519 x 561	N_N_-B207821ULS	2,878 3,089
Specify the surface type (1, 2). Specify the handle curve: left (L) or double (D). Specify the fronts finish (B, W, N).				

High-Gloss Black (B) or High-Gloss White (W) fronts finish option: add \$323.

STORAGE MODULES – 27" H

W x D x H (in)	W x D x H (mm)	Code	All Laminate (\$)	HPL Surfaces (\$)
Storage modules with drawers – 27" H				
<i>2 file drawers with soft-close. No soft-close mechanism on 24" (600 mm) wide file drawer. Suspension bars. Locks.</i>				
	24 x 24 x 27	600 x 619 x 690	N_N_-FF242427	1,576 1,717
	16 x 24 x 27	409 x 619 x 690	N_N_-FF241627	1,475 1,597
	24 x 20 x 27	600 x 519 x 690	N_N_-FF202427	1,526 1,661
	16 x 20 x 27	409 x 519 x 690	N_N_-FF201627	1,426 1,539
Specify the surface type (1, 2). Specify the handle curve: double (D), left (L) or right (R). Specify the fronts finish (B, W, N).				

High-Gloss Black (B) or High-Gloss White (W) fronts finish option: add \$122.

W x D x H (in)	W x D x H (mm)	Code	All Laminate (\$)	HPL Surfaces (\$)
Storage modules with drawers – 27" H				
<i>2 box drawers and 1 file drawer with soft-close. No soft-close mechanism on 24" (600 mm) wide file drawer. Suspension bar. Pencil tray. Lock.</i>				
	24 x 24 x 27	600 x 619 x 690	N_N_-UF242427	1,863 2,026
	16 x 24 x 27	409 x 619 x 690	N_N_-UF241627	1,775 1,918
	24 x 20 x 27	600 x 519 x 690	N_N_-UF202427	1,818 1,969
	16 x 20 x 27	409 x 519 x 690	N_N_-UF201627	1,733 1,869
Specify the surface type (1, 2). Specify the handle curve: double (D), left (L) or right (R). Specify the fronts finish (B, W, N).				

High-Gloss Black (B) or High-Gloss White (W) fronts finish option: add \$122.

W x D x H (in)	W x D x H (mm)	Code	All Laminate (\$)	HPL Surfaces (\$)
Storage modules with drawers – 27" H				
<i>2 file drawers with suspension bars. Lock.</i>				
	36 x 24 x 27	900 x 619 x 690	N_N_-LF243627	1,756 1,934
	30 x 24 x 27	750 x 619 x 690	N_N_-LF243027	1,689 1,854
	36 x 20 x 27	900 x 519 x 690	N_N_-LF203627	1,717 1,881
	30 x 20 x 27	750 x 519 x 690	N_N_-LF203027	1,656 1,805
Specify the surface type (1, 2). Specify the handle curve: double (D), left (L) or right (R). Specify the fronts finish (B, W, N).				

High-Gloss Black (B) or High-Gloss White (W) fronts finish option: add \$160.

W x D x H (in)	W x D x H (mm)	Code	All Laminate (\$)	HPL Surfaces (\$)
Storage modules with drawers – 27" H				
<i>2 box drawers with soft-close. 1 file drawer. Suspension bar. Pencil tray. Lock.</i>				
	36 x 24 x 27	900 x 619 x 690	N_N_-LUF243627	2,070 2,270
	30 x 24 x 27	750 x 619 x 690	N_N_-LUF243027	2,005 2,185
	36 x 20 x 27	900 x 519 x 690	N_N_-LUF203627	2,035 2,220
	30 x 20 x 27	750 x 519 x 690	N_N_-LUF203027	1,969 2,134
Specify the surface type (1, 2). Specify the handle curve: double (D), left (L) or right (R). Specify the fronts finish (B, W, N).				

High-Gloss Black (B) or High-Gloss White (W) fronts finish option: add \$160.

W x D x H (in)	W x D x H (mm)	Code	All Laminate (\$)	HPL Surfaces (\$)
Storage modules with drawers on left, hidden space on right – 27" H				
<i>2 file drawers with suspension bars. Lock. 12" W (284 mm) hidden space on right.</i>				
	48 x 24 x 27	1200 x 619 x 690	N_N_-244827LFS	2,090 2,314
	42 x 24 x 27	1050 x 619 x 690	N_N_-244227LFS	2,035 2,241
	48 x 20 x 27	1200 x 519 x 690	N_N_-204827LFS	2,040 2,241
	42 x 20 x 27	1050 x 519 x 690	N_N_-204227LFS	1,984 2,179
Specify the surface type (1, 2). Specify the handle curve: double (D), left (L) or right (R). Specify the fronts finish (B, W, N).				

High-Gloss Black (B) or High-Gloss White (W) fronts finish option: add \$242.

W x D x H (in)	W x D x H (mm)	Code	All Laminate (\$)	HPL Surfaces (\$)
Storage modules with drawers on right, hidden space on left – 27" H				
<i>2 file drawers with suspension bars. Lock. 12" W (284 mm) hidden space on left.</i>				
	48 x 24 x 27	1200 x 619 x 690	N_N_-LFS244827	2,090 2,314
	42 x 24 x 27	1050 x 619 x 690	N_N_-LFS244227	2,035 2,241
	48 x 20 x 27	1200 x 519 x 690	N_N_-LFS204827	2,040 2,241
	42 x 20 x 27	1050 x 519 x 690	N_N_-LFS204227	1,984 2,179
Specify the surface type (1, 2). Specify the handle curve: double (D), left (L) or right (R). Specify the fronts finish (B, W, N).				

High-Gloss Black (B) or High-Gloss White (W) fronts finish option: add \$242.

W x D x H (in)	W x D x H (mm)	Code	All Laminate (\$)	HPL Surfaces (\$)
Storage modules with drawers on left, open bookcase on right – 27" H				
<i>2 file drawers with soft-close. Suspension bar. Lock. Open bookcase without back on right. 1 adjustable shelf.</i>				
	48 x 24 x 27	1200 x 619 x 690	N_N_-FF244827BE	1,891 2,061
	42 x 24 x 27	1050 x 619 x 690	N_N_-FF244227BE	1,854 2,020
	36 x 24 x 27	900 x 619 x 690	N_N_-FF243627BE	1,818 1,969
	30 x 24 x 27	750 x 619 x 690	N_N_-FF243027BE	1,792 1,918
	48 x 20 x 27	1200 x 519 x 690	N_N_-FF204827BE	1,812 1,961
	42 x 20 x 27	1050 x 519 x 690	N_N_-FF204227BE	1,775 1,918
	36 x 20 x 27	900 x 519 x 690	N_N_-FF203627BE	1,747 1,876
	30 x 20 x 27	750 x 519 x 690	N_N_-FF203027BE	1,711 1,834
Specify the surface type (1, 2). Specify the handle curve: right (R) or double (D). Specify the front finish (B, W, N).				

High-Gloss Black (B) or High-Gloss White (W) front finish option: add \$81.

W x D x H (in)	W x D x H (mm)	Code	All Laminate (\$)	HPL Surfaces (\$)
Storage modules with drawers on right, open bookcase on left – 27" H				
<i>2 file drawers with soft-close. Suspension bars. Lock. Open bookcase without back on left. 1 adjustable shelf.</i>				
	48 x 24 x 27	1200 x 619 x 690	N_N_-BE244827FF	1,891 2,061
	42 x 24 x 27	1050 x 619 x 690	N_N_-BE244227FF	1,854 2,020
	36 x 24 x 27	900 x 619 x 690	N_N_-BE243627FF	1,818 1,969
	30 x 24 x 27	750 x 619 x 690	N_N_-BE243027FF	1,792 1,918
	48 x 20 x 27	1200 x 519 x 690	N_N_-BE204827FF	1,812 1,961
	42 x 20 x 27	1050 x 519 x 690	N_N_-BE204227FF	1,775 1,918
	36 x 20 x 27	900 x 519 x 690	N_N_-BE203627FF	1,747 1,876
	30 x 20 x 27	750 x 519 x 690	N_N_-BE203027FF	1,711 1,834
Specify the surface type (1, 2). Specify the handle curve: left (L) or double (D). Specify the fronts finish (B, W, N).				

High-Gloss Black (B) or High-Gloss White (W) fronts finish option: add \$81.

W x D x H (in)	W x D x H (mm)	Code	All Laminate (\$)	HPL Surfaces (\$)
Storage modules with drawers on left, open bookcase on right – 27" H				
<i>2 box drawers and 1 file drawer with soft-close. Suspension bar. Pencil tray. Lock. Open bookcase without back on right. 1 adjustable shelf.</i>				
	48 x 24 x 27	1200 x 619 x 690	N_N_-UF244827BE	2,112 2,292
	42 x 24 x 27	1050 x 619 x 690	N_N_-UF244227BE	2,084 2,247
	36 x 24 x 27	900 x 619 x 690	N_N_-UF243627BE	2,056 2,205
	30 x 24 x 27	750 x 619 x 690	N_N_-UF243027BE	2,026 2,162
	48 x 20 x 27	1200 x 519 x 690	N_N_-UF204827BE	2,040 2,191
	42 x 20 x 27	1050 x 519 x 690	N_N_-UF204227BE	2,012 2,156
	36 x 20 x 27	900 x 519 x 690	N_N_-UF203627BE	1,984 2,112
	30 x 20 x 27	750 x 519 x 690	N_N_-UF203027BE	1,954 2,078
Specify the surface type (1, 2). Specify the handle curve: right (R) or double (D). Specify the fronts finish (B, W, N).				

High-Gloss Black (B) or High-Gloss White (W) fronts finish option: add \$81.

W x D x H (in)	W x D x H (mm)	Code	All Laminate (\$)	HPL Surfaces (\$)
Storage modules with drawers on right, open bookcase on left – 27" H				
<i>2 box drawers and 1 file drawer with soft-close. Suspension bar. Pencil tray. Lock. Open bookcase without back on left. 1 adjustable shelf.</i>				
	48 x 24 x 27	1200 x 619 x 690	N_N_-BE244827UF	2,112 2,292
	42 x 24 x 27	1050 x 619 x 690	N_N_-BE244227UF	2,084 2,247
	36 x 24 x 27	900 x 619 x 690	N_N_-BE243627UF	2,056 2,205
	30 x 24 x 27	750 x 619 x 690	N_N_-BE243027UF	2,026 2,162
	48 x 20 x 27	1200 x 519 x 690	N_N_-BE204827UF	2,040 2,191
	42 x 20 x 27	1050 x 519 x 690	N_N_-BE204227UF	2,012 2,156
	36 x 20 x 27	900 x 519 x 690	N_N_-BE203627UF	1,984 2,112
	30 x 20 x 27	750 x 519 x 690	N_N_-BE203027UF	1,954 2,078
Specify the surface type (1, 2). Specify the handle curve: left (L) or double (D). Specify the fronts finish (B, W, N).				

High-Gloss Black (B) or High-Gloss White (W) fronts finish option: add \$81.

W x D x H (in)	W x D x H (mm)	Code	All Laminate (\$)	HPL Surfaces (\$)
Storage modules with drawers on left, open bookcase on right – 27" H				
<i>2 box drawers and 1 file drawer with soft-close. Suspension bar. Pencil tray. Lock. Open bookcase without back on left. 1 adjustable shelf.</i>				
	48 x 24 x 27	1200 x 619 x 690	N_N_-LUF244827UF	2,112 2,292
	42 x 24 x 27	1050 x 619 x 690	N_N_-LUF244227UF	2,084 2,247
	36 x 24 x 27	900 x 619 x 690	N_N_-LUF243627UF	2,056 2,205
	30 x 24 x 27	750 x 619 x 690	N_N_-LUF243027UF	2,026 2,162
	48 x 20 x 27	1200 x 519 x 690	N_N_-LUF204827UF	2,040 2,191
	42 x 20 x 27	1050 x 519 x 690	N_N_-LUF204227UF	2,012 2,156
	36 x 20 x 27	900 x 519 x 690	N_N_-LUF203627UF	1,984 2,112
	30 x 20 x 27	750 x 519 x 690	N_N_-LUF203027UF	1,954 2,078
Specify the surface type (1, 2). Specify the handle curve: left (L) or double (D). Specify the fronts finish (B, W, N).				

High-Gloss Black (B) or High-Gloss White (W) fronts finish option: add \$81.

W x D x H (in)	W x D x H (mm)	Code	All Laminate (\$)	HPL Surfaces (\$)
Storage modules with drawers on right, open bookcase on left – 27" H				
<i>2 box drawers and 1 file drawer with soft-close. Suspension bar. Pencil tray. Lock. Open bookcase without back on left. 1 adjustable shelf.</i>				
	48 x 24 x 27	1200 x 619 x 690	N_N_-LBE244827UF	2,112 2,292
	42 x 24 x 27	1050 x 619 x 690	N_N_-LBE244227UF	2,084 2,247
	36 x 24 x 27	900 x 619 x 690	N_N_-LBE243627UF	2,056 2,205
	30 x 24 x 27	750 x 619 x 690	N_N_-LBE243027UF	2,026 2,162
	48 x 20 x 27	1200 x 519 x 690	N_N_-LBE204827UF	2,040 2,191
	42 x 20 x 27	1050 x 519 x 690	N_N_-LBE204227UF	2,012 2,156
	36 x 20 x 27	900 x 519 x 690	N_N_-LBE203627UF	1,984 2,112
	30 x 20 x 27	750 x 519 x 690	N_N_-LBE203027UF	1,954 2,078
Specify the surface type (1, 2). Specify the handle curve: left (L) or double (D). Specify the fronts finish (B, W, N).				

High-Gloss Black (B) or High-Gloss White (W) fronts finish option: add \$81.

	W x D x H (in)	W x D x H (mm)	Code	All Laminate (\$)	HPL Surfaces (\$)
Storage modules with doors – 27" H	<i>2 doors with soft-close. Lock. 48" to 42" W (1200 to 1050 mm): 2 adjustable shelves; 36" to 30" W (900 to 750 mm): 1 adjustable shelf.</i>				
	48 x 24 x 27	1200 x 619 x 690	N_NN_-244827B	1,783	1,949
	42 x 24 x 27	1050 x 619 x 690	N_NN_-244227B	1,661	1,812
	36 x 24 x 27	900 x 619 x 690	N_NN_-243627B	1,539	1,669
	30 x 24 x 27	750 x 619 x 690	N_NN_-243027B	1,411	1,531
	48 x 20 x 27	1200 x 519 x 690	N_NN_-204827B	1,726	1,876
	42 x 20 x 27	1050 x 519 x 690	N_NN_-204227B	1,604	1,739
	36 x 20 x 27	900 x 519 x 690	N_NN_-203627B	1,490	1,604
	30 x 20 x 27	750 x 519 x 690	N_NN_-203027B	1,368	1,475
	Specify the surface type (1, 2). Specify the fronts finish (B, W, N).				

	W x D x H (in)	W x D x H (mm)	Code	All Laminate (\$)	HPL Surfaces (\$)
Storage modules with door – 27" H	<i>1 door with soft-close. Lock. 1 adjustable shelf.</i>				
	24 x 24 x 27	600 x 619 x 690	N_NN_-242427B	1,180	1,282
	16 x 24 x 27	409 x 619 x 690	N_NN_-241627B	1,102	1,189
	24 x 20 x 27	600 x 519 x 690	N_NN_-202427B	1,146	1,239
	16 x 20 x 27	409 x 519 x 690	N_NN_-201627B	1,067	1,140
	Specify the surface type (1, 2). Specify the handle curve: left (L) or right (R). Specify the front finish (B, W, N).				

	W x D x H (in)	W x D x H (mm)	Code	All Laminate (\$)	HPL Surfaces (\$)
Storage modules with door on left, open bookcase on right – 27" H	<i>1 door with soft-close. Lock. Open bookcase without back on right. Hinges on right. 2 adjustable shelves.</i>				
	48 x 24 x 27	1200 x 619 x 690	N_NN_-B244827BE	1,526	1,683
	42 x 24 x 27	1050 x 619 x 690	N_NN_-B244227BE	1,490	1,638
	36 x 24 x 27	900 x 619 x 690	N_NN_-B243627BE	1,462	1,597
	30 x 24 x 27	750 x 619 x 690	N_NN_-B243027BE	1,432	1,555
	48 x 20 x 27	1200 x 519 x 690	N_NN_-B204827BE	1,439	1,576
	42 x 20 x 27	1050 x 519 x 690	N_NN_-B204227BE	1,411	1,539
	36 x 20 x 27	900 x 519 x 690	N_NN_-B203627BE	1,382	1,496
	30 x 20 x 27	750 x 519 x 690	N_NN_-B203027BE	1,354	1,453
	Specify the surface type (1, 2). Specify the handle curve: right (R) or double (D). Specify the front finish (B, W, N).				

	W x D x H (in)	W x D x H (mm)	Code	All Laminate (\$)	HPL Surfaces (\$)
Storage modules with door on right, open bookcase on left – 27" H	<i>1 door with soft-close. Lock. Open bookcase without back on left. Hinges on left. 2 adjustable shelves.</i>				
	48 x 24 x 27	1200 x 619 x 690	N_NN_-BE244827B	1,526	1,683
	42 x 24 x 27	1050 x 619 x 690	N_NN_-BE244227B	1,490	1,638
	36 x 24 x 27	900 x 619 x 690	N_NN_-BE243627B	1,462	1,597
	30 x 24 x 27	750 x 619 x 690	N_NN_-BE243027B	1,432	1,555
	48 x 20 x 27	1200 x 519 x 690	N_NN_-BE204827B	1,439	1,576
	42 x 20 x 27	1050 x 519 x 690	N_NN_-BE204227B	1,411	1,539
	36 x 20 x 27	900 x 519 x 690	N_NN_-BE203627B	1,382	1,496
	30 x 20 x 27	750 x 519 x 690	N_NN_-BE203027B	1,354	1,453
	Specify the surface type (1, 2). Specify the handle curve: left (L) or double (D). Specify the front finish (B, W, N).				

	W x D x H (in)	W x D x H (mm)	Code	All Laminate (\$)	HPL Surfaces (\$)
Storage modules with drawers on left, open bookcase on right – 27" H	<i>2 file drawers with suspension bars. Lock. Open bookcase without back on right. 1 adjustable shelf.</i>				
	72 x 20 x 27	1800 x 519 x 690	N_NN_-LF207227BE	2,220	2,436
	60 x 20 x 27	1500 x 519 x 690	N_NN_-LF206027BE	2,112	2,298
	Specify the surface type (1, 2). Specify the handle curve: right (R) or double (D). Specify the fronts finish (B, W, N).				

	W x D x H (in)	W x D x H (mm)	Code	All Laminate (\$)	HPL Surfaces (\$)
Storage modules with drawers on right, open bookcase on left – 27" H	<i>2 file drawers with suspension bars. Lock. Open bookcase without back on left. 1 adjustable shelf.</i>				
	72 x 20 x 27	1800 x 519 x 690	N_NN_-BE207227LF	2,220	2,436
	60 x 20 x 27	1500 x 519 x 690	N_NN_-BE206027LF	2,112	2,298
	Specify the surface type (1, 2). Specify the handle curve: left (L) or double (D). Specify the fronts finish (B, W, N).				

	W x D x H (in)	W x D x H (mm)	Code	All Laminate (\$)	HPL Surfaces (\$)
Storage modules with drawers on left, open bookcase on right – 27" H	<i>2 box drawers with soft-close and 1 file drawer. Suspension bar. Pencil tray. Lock. Open bookcase without back on right. 1 adjustable shelf.</i>				
	72 x 20 x 27	1800 x 519 x 690	N_NN_-LUF207227BE	2,456	2,671
	60 x 20 x 27	1500 x 519 x 690	N_NN_-LUF206027BE	2,341	2,536
	Specify the surface type (1, 2). Specify the handle curve: right (R) or double (D). Specify the fronts finish (B, W, N).				

	W x D x H (in)	W x D x H (mm)	Code	All Laminate (\$)	HPL Surfaces (\$)
Storage modules with drawers on right, open bookcase on left – 27" H	<i>2 box drawers with soft-close and 1 file drawer. Suspension bar. Pencil tray. Lock. Open bookcase without back on left. 1 adjustable shelf.</i>				
	72 x 20 x 27	1800 x 519 x 690	N_NN_-BE207227LUF	2,456	2,671
	60 x 20 x 27	1500 x 519 x 690	N_NN_-BE206027LUF	2,341	2,536
	Specify the surface type (1, 2). Specify the handle curve: left (L) or double (D). Specify the fronts finish (B, W, N).				

	W x D x H (in)	W x D x H (mm)	Code	All Laminate (\$)	HPL Surfaces (\$)
Storage modules with drawers on left, hidden space on right, open bookcase on right – 27" H	<i>2 file drawers with suspension bar. Lock. 12" W (284 mm) hidden space on right. Open bookcase without back on right. 96" to 90" W (2400 to 2250 mm): 2 adjustable shelves; 84" to 72" W (2100 to 1800 mm): 1 adjustable shelf.</i>				
	96"-90"	2400 x 519 x 690	N_NN_-LFS209627BE	2,835	3,116
	90 x 20 x 27	2250 x 519 x 690	N_NN_-LFS209027BE	2,751	3,009
	84 x 20 x 27	2100 x 519 x 690	N_NN_-LFS208427BE	2,656	2,908
	78 x 20 x 27	1950 x 519 x 690	N_NN_-LFS207827BE	2,571	2,808
	72 x 20 x 27	1800 x 519 x 690	N_NN_-LFS207227BE	2,477	2,706
	Specify the surface type (1, 2). Specify the handle curve: right (R) or double (D). Specify the fronts finish (B, W, N).				

	W x D x H (in)	W x D x H (mm)	Code	All Laminate (\$)	HPL Surfaces (\$)
Storage modules with drawers on right, hidden space on left, open bookcase on left – 27" H	<i>2 file drawers with suspension bar. Lock. 12" W (284 mm) hidden space on left. Open bookcase without back on left. 96" to 90" W (2400 to 2250 mm): 2 adjustable shelves; 84" to 72" W (2100 to 1800 mm): 1 adjustable shelf.</i>				
	96"-90"	2400 x 519 x 690	N_NN_-BE209627LFS	2,835	3,116
	90 x 20 x 27	2250 x 519 x 690	N_NN_-BE209027LFS	2,751	3,009
	84 x 20 x 27	2100 x 519 x 690	N_NN_-BE208427LFS	2,656	2,908
	78 x 20 x 27	1950 x 519 x 690	N_NN_-BE207827LFS	2,571	2,808
	72 x 20 x 27	1800 x 519 x 690	N_NN_-BE207227LFS	2,477	2,706
	Specify the surface type (1, 2). Specify the handle curve: left (L) or double (D). Specify the fronts finish (B, W, N).				

	W x D x H (in)	W x D x H (mm)	Code	All Laminate (\$)	HPL Surfaces (\$)
Double storage modules with drawers – 27" H	<i>4 file drawers with suspension bars. Lock.</i>				
	72 x 20 x 27	1800 x 519 x 690	N_NN_-LF207227LF	3,230	3,487
	60 x 20 x 27	1500 x 519 x 690	N_NN_-LF206027LF	3,087	3,313
	Specify the surface type (1, 2). Specify the fronts finish (B, W, N).				

2-TONE LAMINATE APPLICATION: SHADED AREA CORRESPONDS TO THE FIRST CODE TO BE SPECIFIED.
SECOND LAMINATE CODE WILL BE APPLIED TO THE REST OF THE PRODUCT.

	W x D x H (in)	W x D x H (mm)	Code	All Laminate (\$)	HPL Surfaces (\$)
Storage modules with doors on left, open bookcase on right – 27" H					
<i>2 doors with soft-close. Lock. Open bookcase without back on right. 96" to 84" W (2400 to 2100 mm): 4 adjustable shelves; 78" to 60" W (1950 to 1500 mm): 2 adjustable shelves.</i>					
	96" x 20" x 27"	2400 x 519 x 690	N_NN_-B209627BE	2,521	2,785
	90" x 20" x 27"	2250 x 519 x 690	N_NN_-B209027BE	2,399	2,650
	84" x 20" x 27"	2100 x 519 x 690	N_NN_-B208427BE	2,278	2,514
	78" x 20" x 27"	1950 x 519 x 690	N_NN_-B207827BE	2,156	2,376
	72" x 20" x 27"	1800 x 519 x 690	N_NN_-B207227BE	2,040	2,241
	66" x 20" x 27"	1650 x 519 x 690	N_NN_-B206627BE	1,918	2,107
	60" x 20" x 27"	1500 x 519 x 690	N_NN_-B206027BE	1,798	1,969
Specify the surface type (1, 2). Specify the fronts finish (B, W, N).					

High-Gloss Black (B) or High-Gloss White (W) fronts finish option: add \$242.

	W x D x H (in)	W x D x H (mm)	Code	All Laminate (\$)	HPL Surfaces (\$)
Storage modules with doors on right, open bookcase on left – 27" H					
<i>2 doors with soft-close. Lock. Open bookcase without back on left. 96" to 84" W (2400 to 2100 mm): 4 adjustable shelves; 78" to 60" W (1950 to 1500 mm): 2 adjustable shelves.</i>					
	96" x 20" x 27"	2400 x 519 x 690	N_NN_-BE209627B	2,521	2,785
	90" x 20" x 27"	2250 x 519 x 690	N_NN_-BE209027B	2,399	2,650
	84" x 20" x 27"	2100 x 519 x 690	N_NN_-BE208427B	2,278	2,514
	78" x 20" x 27"	1950 x 519 x 690	N_NN_-BE207827B	2,156	2,376
	72" x 20" x 27"	1800 x 519 x 690	N_NN_-BE207227B	2,040	2,241
	66" x 20" x 27"	1650 x 519 x 690	N_NN_-BE206627B	1,918	2,107
	60" x 20" x 27"	1500 x 519 x 690	N_NN_-BE206027B	1,798	1,969
Specify the surface type (1, 2). Specify the fronts finish (B, W, N).					

High-Gloss Black (B) or High-Gloss White (W) fronts finish option: add \$242.

	W x D x H (in)	W x D x H (mm)	Code	All Laminate (\$)	HPL Surfaces (\$)
Double storage modules with doors – 27" H					
<i>4 doors with soft-close. Locks. 96" to 84" W (2400 to 2250 mm): 4 adjustable shelves; 78" to 60" W (2100 to 1800 mm): 2 adjustable shelves.</i>					
	96" x 20" x 27"	2400 x 519 x 690	N_NN_-B209627B	3,395	3,688
	90" x 20" x 27"	2250 x 519 x 690	N_NN_-B209027B	3,236	3,524
	84" x 20" x 27"	2100 x 519 x 690	N_NN_-B208427B	3,087	3,359
	78" x 20" x 27"	1950 x 519 x 690	N_NN_-B207827B	2,936	3,187
	72" x 20" x 27"	1800 x 519 x 690	N_NN_-B207227B	2,785	3,021
	66" x 20" x 27"	1650 x 519 x 690	N_NN_-B206627B	2,635	2,858
	60" x 20" x 27"	1500 x 519 x 690	N_NN_-B206027B	2,485	2,683
Specify the surface type (1, 2). Specify the fronts finish (B, W, N).					

High-Gloss Black (B) or High-Gloss White (W) fronts finish option: add \$386.

	W x D x H (in)	W x D x H (mm)	Code	All Laminate (\$)	HPL Surfaces (\$)
Storage modules with drawers on left and doors on right – 27" H					
<i>2 file drawers with suspension bars. Locks. 2 doors with soft-close on right. 1 adjustable shelf.</i>					
	72" x 20" x 27"	1800 x 519 x 690	N_N_-LF207227B	2,727	2,958
	60" x 20" x 27"	1500 x 519 x 690	N_N_-LF206027B	2,607	2,808
Specify the surface type (1, 2). Specify the handle curve: right (R) or double (D). Specify the fronts finish (B, W, N).					

High-Gloss Black (B) or High-Gloss White (W) fronts finish option: add \$283.

	W x D x H (in)	W x D x H (mm)	Code	All Laminate (\$)	HPL Surfaces (\$)
Storage modules with drawers on right and doors on left – 27" H					
<i>2 file drawers with suspension bars. Locks. 2 doors with soft-close on left. 1 adjustable shelf.</i>					
	72" x 20" x 27"	1800 x 519 x 690	N_N_-B207227LF	2,727	2,958
	60" x 20" x 27"	1500 x 519 x 690	N_N_-B206027LF	2,607	2,808
Specify the surface type (1, 2). Specify the handle curve: left (L) or double (D). Specify the fronts finish (B, W, N).					

High-Gloss Black (B) or High-Gloss White (W) fronts finish option: add \$283.

STORAGE FURNITURE

	W x D x H (in)	W x D x H (mm)	Code	All Laminate (\$)	HPL Surfaces (\$)
Lateral file unit					
<i>3 file drawers with suspension bars. Lock.</i>					
	36" x 20" x 41"	900 x 519 x 1025	NNN_-203640LF3		3,038



High-Gloss Black (B) or High-Gloss White (W) fronts finish option: add \$242.

Specify the handle curve: double (D), left (L) or right (R). Specify the fronts finish (B, W, N).

	W x D x H (in)	W x D x H (mm)	Code	All Laminate (\$)	HPL Surfaces (\$)
Lateral file unit/bookcase with lift-up door					
<i>2 file drawers with suspension bars. Lock on file drawers. Open bookcase. 1 adjustable shelf. Assisted lift-up door with soft-close.</i>					
	36" x 20" x 73"	900 x 519 x 1850	NNN_-203673LFBVEV		3,400



High-Gloss Black (B) or High-Gloss White (W) fronts finish option: add \$242.

Specify the handle curve: double (D), left (L) or right (R). Specify the fronts finish (B, W, N).

	W x D x H (in)	W x D x H (mm)	Code	All Laminate (\$)	HPL Surfaces (\$)
Lateral file unit/bookcase with metal shelf and lift-up door					
<i>2 file drawers with suspension bars. Lock on file drawers. Open bookcase. 1 adjustable 15" D (375 mm) metal shelf. Assisted lift-up door with soft-close.</i>					
	36" x 20" x 73"	900 x 519 x 1850	NNN_-203673LFBVEVM		3,792

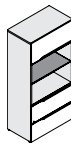

High-Gloss Black (B) or High-Gloss White (W) fronts finish option: add \$242.

Specify the handle curve: double (D), left (L) or right (R). Specify the fronts finish (B, W, N). Specify the shelf finish (K, W).

	W x D x H (in)	W x D x H (mm)	Code	All Laminate (\$)	HPL Surfaces (\$)
Storage cabinets with doors					
<i>2 doors with soft-close. Lock. 73" to 65" H (1850 to 1659 mm): 3 adjustable shelves and 1 fixed shelf; 57" H (1468 mm): 3 adjustable shelves; 49" H (1277 mm): 2 adjustable shelves.</i>					
	36" x 20" x 73"	900 x 519 x 1850	NNNN_-203673B		2,442
	36" x 20" x 65"	900 x 519 x 1659	NNNN_-203665B		2,387
	36" x 20" x 57"	900 x 519 x 1468	NNNN_-203657B		2,322
	36" x 20" x 49"	900 x 519 x 1277	NNNN_-203649B		2,144
	30" x 20" x 73"	750 x 519 x 1850	NNNN_-203073B		2,296
	30" x 20" x 65"	750 x 519 x 1659	NNNN_-203065B		2,241
	30" x 20" x 57"	750 x 519 x 1468	NNNN_-203057B		2,175
	30" x 20" x 49"	750 x 519 x 1277	NNNN_-203049B		2,001

High-Gloss Black (B) or High-Gloss White (W) fronts finish option: add \$484.

Specify the fronts finish (B, W, N).

	W x D x H (in)	W x D x H (mm)	Code	All Laminate (\$)	HPL Surfaces (\$)
Storage cabinets with door					
<i>1 door with soft-close. Lock. 73" to 65" H (1850 to 1659 mm): 4 adjustable shelves; 57" H (1468 mm): 3 adjustable shelves; 49" H (1277 mm): 2 adjustable shelves.</i>					
	24" x 20" x 73"	600 x 519 x 1850	NNN_-202473B		1,780
	24" x 20" x 65"	600 x 519 x 1659	NNN_-202465B		1,732
	24" x 20" x 57"	600 x 519 x 1468	NNN_-202457B		1,676
	24" x 20" x 49"	600 x 519 x 1277	NNN_-202449B		1,628
	20" x 20" x 73"	500 x 519 x 1850	NNN_-202073B		1,716
	20" x 20" x 65"	500 x 519 x 1659	NNN_-202065B		1,669
	20" x 20" x 57"	500 x 519 x 1468	NNN_-202057B		1,621
	20" x 20" x 49"	500 x 519 x 1277	NNN_-202049B		1,572

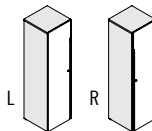

High-Gloss Black (B) or High-Gloss White (W) front finish option: add \$242.

Specify the opening: left (L) or right (R). Specify the front finish (B, W, N)

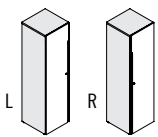
	W x D x H (in)	W x D x H (mm)	Code	All Laminate (\$)
Wardrobe units with door	<i>1 door with soft-close. Lock. Clothes hanger bar and 1 fixed shelf.</i>			
	20 x 20 x 73	500 x 519 x 1850	NNN_-202073BC	1,854
	20 x 20 x 65	500 x 519 x 1659	NNN_-202065BC	1,806
	20 x 20 x 57	500 x 519 x 1468	NNN_-202057BC	1,749
	20 x 20 x 49	500 x 519 x 1277	NNN_-202049BC	1,690
	14 x 20 x 73	350 x 519 x 1850	NNN_-201473BC	1,760
	14 x 20 x 65	350 x 519 x 1659	NNN_-201465BC	1,709
	14 x 20 x 57	350 x 519 x 1468	NNN_-201457BC	1,660
	14 x 20 x 49	350 x 519 x 1277	NNN_-201449BC	1,621
High-Gloss Black (B) or High-Gloss White (W) front finish option: add \$242.	Specify the opening: left (L) or right (R). Specify the front finish (B, W, N)			

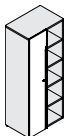
	W x D x H (in)	W x D x H (mm)	Code	All Laminate (\$)
Wardrobe units with open bookcase on right	<i>1 door with soft-close. Lock. Clothes hanger bar and 1 fixed shelf on wardrobe side. Open bookcase on right.</i>			
	<i>73" to 65" H (1850 to 1659 mm): 4 adjustable shelves;</i>			
	<i>57" H (1468 mm): 3 adjustable shelves;</i>			
	<i>49" H (1277 mm): 2 adjustable shelves.</i>			
	30 x 20 x 73	750 x 519 x 1850	NNNN_-203073CBE	2,305
	30 x 20 x 65	750 x 519 x 1659	NNNN_-203065CBE	2,281
	30 x 20 x 57	750 x 519 x 1468	NNNN_-203057CBE	2,247
	30 x 20 x 49	750 x 519 x 1277	NNNN_-203049CBE	2,022
High-Gloss Black (B) or High-Gloss White (W) front finish option: add \$160.	Specify the front finish (B, W, N)			

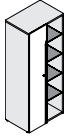
	W x D x H (in)	W x D x H (mm)	Code	All Laminate (\$)
Wardrobe units with open bookcase and metal shelves on right	<i>1 door with soft-close. Lock. Clothes hanger bar and 1 fixed shelf on wardrobe side. Open bookcase on right.</i>			
	<i>73" to 65" H (1850 to 1659 mm): 4 adjustable 15" D (375 mm) metal shelves;</i>			
	<i>57" H (1468 mm): 3 adjustable 15" D (375 mm) metal shelves;</i>			
	<i>49" H (1277 mm): 2 adjustable 15" D (375 mm) metal shelves.</i>			
	30 x 20 x 73	750 x 519 x 1850	NNNN_-203073CBEM	2,593
	30 x 20 x 65	750 x 519 x 1659	NNNN_-203065CBEM	2,566
	30 x 20 x 57	750 x 519 x 1468	NNNN_-203057CBEM	2,464
	30 x 20 x 49	750 x 519 x 1277	NNNN_-203049CBEM	2,162
High-Gloss Black (B) or High-Gloss White (W) front finish option: add \$160.	Specify the front finish (B, W, N) Specify the shelves finish (K, W).			

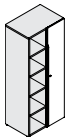
	W x D x H (in)	W x D x H (mm)	Code	All Laminate (\$)
Wardrobe units with open bookcase on left	<i>1 door with soft-close. Lock. Clothes hanger bar and 1 fixed shelf on wardrobe side. Open bookcase on left.</i>			
	<i>73" to 65" H (1850 to 1659 mm): 4 adjustable shelves;</i>			
	<i>57" H (1468 mm): 3 adjustable shelves;</i>			
	<i>49" H (1277 mm): 2 adjustable shelves.</i>			
	30 x 20 x 73	750 x 519 x 1850	NNNN_-BEC203073	2,305
	30 x 20 x 65	750 x 519 x 1659	NNNN_-BEC203065	2,281
	30 x 20 x 57	750 x 519 x 1468	NNNN_-BEC203057	2,247
	30 x 20 x 49	750 x 519 x 1277	NNNN_-BEC203049	2,022
High-Gloss Black (B) or High-Gloss White (W) front finish option: add \$160.	Specify the front finish (B, W, N)			

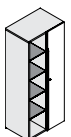
	W x D x H (in)	W x D x H (mm)	Code	All Laminate (\$)
Wardrobe units with open bookcase and metal shelves on left	<i>1 door with soft-close. Lock. Clothes hanger bar and 1 fixed shelf on wardrobe side. Open bookcase on left.</i>			
	<i>73" to 65" H (1850 to 1659 mm): 4 adjustable 15" D (375 mm) metal shelves;</i>			
	<i>57" H (1468 mm): 3 adjustable 15" D (375 mm) metal shelves;</i>			
	<i>49" H (1277 mm): 2 adjustable 15" D (375 mm) metal shelves.</i>			
	30 x 20 x 73	750 x 519 x 1850	NNNN_-BEC203073M	2,593
	30 x 20 x 65	750 x 519 x 1659	NNNN_-BEC203065M	2,566
	30 x 20 x 57	750 x 519 x 1468	NNNN_-BEC203057M	2,464
	30 x 20 x 49	750 x 519 x 1277	NNNN_-BEC203049M	2,162
High-Gloss Black (B) or High-Gloss White (W) front finish option: add \$160.	Specify the front finish (B, W, N) Specify the shelves finish (K, W).			

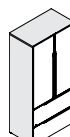
	W x D x H (in)	W x D x H (mm)	Code	All Laminate (\$)
Storage lateral file cabinets	<i>2 doors with soft-close. 2 file drawers with suspension bars. Lock on file drawers.</i>			
	<i>73" to 65" H (1850 to 1659 mm): 2 adjustable shelves;</i>			
	<i>57" to 49" H (1468 to 1277 mm): 1 adjustable shelf.</i>			
	36 x 20 x 73	900 x 519 x 1850	NNN_-203673LFB	3,184
	36 x 20 x 65	900 x 519 x 1659	NNN_-203665LFB	3,118
	36 x 20 x 57	900 x 519 x 1468	NNN_-203657LFB	2,949
	36 x 20 x 49	900 x 519 x 1277	NNN_-203649LFB	2,878
High-Gloss Black (B) or High-Gloss White (W) front finish option: add \$484.	Specify the drawers handle curve: double (D), left (L) or right (R). Specify the fronts finish (B, W, N).			

	W x D x H (in)	W x D x H (mm)	Code	All Laminate (\$)
Open bookcases with lateral files	<i>Open bookcase. 2 file drawers with suspension bars. Lock.</i>			
	<i>73" to 65" H (1850 to 1659 mm): 2 adjustable shelves;</i>			
	<i>57" to 49" H (1468 to 1277 mm): 1 adjustable shelf.</i>			
	36 x 20 x 73	900 x 519 x 1850	NNN_-203673LFB	2,662
	36 x 20 x 65	900 x 519 x 1659	NNN_-203665LFB	2,620
	36 x 20 x 57	900 x 519 x 1468	NNN_-203657LFB	2,474
	36 x 20 x 49	900 x 519 x 1277	NNN_-203649LFB	2,425
High-Gloss Black (B) or High-Gloss White (W) front finish option: add \$242.	Specify the handle curve: double (D), left (L) or right (R). Specify the fronts finish (B, W, N).			

	W x D x H (in)	W x D x H (mm)	Code	All Laminate (\$)
Open bookcases with metal shelves and lateral files	<i>Open bookcase. 2 file drawers with suspension bars. Lock.</i>			
	<i>73" to 65" H (1850 to 1659 mm): 2 adjustable 15" D (375 mm) metal shelves;</i>			
	<i>57" to 49" H (1468 to 1277 mm): 1 adjustable 15" D (375 mm) metal shelf.</i>			
	36 x 20 x 73	900 x 519 x 1850	NNN_-203673LFBEM	3,087
	36 x 20 x 65	900 x 519 x 1659	NNN_-203665LFBEM	3,051
	36 x 20 x 57	900 x 519 x 1468	NNN_-203657LFBEM	2,683
	36 x 20 x 49	900 x 519 x 1277	NNN_-203649LFBEM	2,643
High-Gloss Black (B) or High-Gloss White (W) front finish option: add \$242.	Specify the handle curve: double (D), left (L) or right (R). Specify the fronts finish (B, W, N). Specify the shelves finish (K, W).			

	W x D x H (in)	W x D x H (mm)	Code	All Laminate (\$)
Open bookcases with doors	<i>Open bookcase. 2 doors with soft-close. Lock.</i>			
	<i>73" to 65" H (1850 to 1659 mm): 3 adjustable shelves;</i>			
	<i>57" to 49" H (1468 to 1277 mm): 2 adjustable shelves.</i>			
	36 x 20 x 73	900 x 519 x 1850	NNNN_-203673BBE	2,425
	36 x 20 x 65	900 x 519 x 1659	NNNN_-203665BBE	2,387
	36 x 20 x 57	900 x 519 x 1468	NNNN_-203657BBE	2,241
	36 x 20 x 49	900 x 519 x 1277	NNNN_-203649BBE	2,191
High-Gloss Black (B) or High-Gloss White (W) front finish option: add \$242.	Specify the fronts finish (B, W, N).			

	W x D x H (in)	W x D x H (mm)	Code	All Laminate (\$)
Open bookcases with metal doors and shelves	<i>Open bookcase. 2 doors with soft-close. Lock.</i>			
	<i>73" to 65" H (1850 to 1659 mm): 2 adjustable 15" D (375 mm) metal shelves and 1 laminate shelf;</i>			
	<i>57" to 49" H (1468 to 1277 mm): 1 adjustable 15" D (375 mm) metal shelf.</i>			
	36 x 20 x 73	900 x 519 x 1850	NNNN_-203673BBEM	2,858
	36 x 20 x 65	900 x 519 x 1659	NNNN_-203665BBEM	2,814
	36 x 20 x 57	900 x 519 x 1468	NNNN_-203657BBEM	2,456
	36 x 20 x 49	900 x 519 x 1277	NNNN_-203649BBEM	2,404
High-Gloss Black (B) or High-Gloss White (W) front finish option: add \$242.	Specify the fronts finish (B, W, N). Specify the shelves finish (K, W).			

2-TONE LAMINATE APPLICATION: SHADED AREA CORRESPONDS TO THE FIRST CODE TO BE SPECIFIED. SECOND LAMINATE CODE WILL BE APPLIED TO THE REST OF THE PRODUCT.

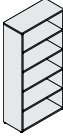
	W x D x H (in)	W x D x H (mm)	Code	All Laminate (\$)
Open bookcases 	<i>1 tone only. 73" H (1850 mm) - 65" H (1659 mm): 4 adjustable shelves;</i>			
	<i>57" H (1468 mm): 3 adjustable shelves;</i>			
	<i>49" H (1277 mm): 2 adjustable shelves.</i>			
	36 x 16 x 73	900 x 400 x 1850	NNNN-B367316	1,518
	36 x 16 x 65	900 x 400 x 1659	NNNN-B366516	1,371
	36 x 16 x 57	900 x 400 x 1468	NNNN-B365716	1,322
	36 x 16 x 49	900 x 400 x 1277	NNNN-B364916	1,176
	30 x 16 x 73	750 x 400 x 1850	NNNN-B307316	1,434
	30 x 16 x 65	750 x 400 x 1659	NNNN-B306516	1,298
	30 x 16 x 57	750 x 400 x 1468	NNNN-B305716	1,264
	30 x 16 x 49	750 x 400 x 1277	NNNN-B304916	1,119
	24 x 16 x 73	600 x 400 x 1850	NNNN-B247316	1,345
	24 x 16 x 65	600 x 400 x 1659	NNNN-B246516	1,225
	24 x 16 x 57	600 x 400 x 1468	NNNN-B245716	1,193
	24 x 16 x 49	600 x 400 x 1277	NNNN-B244916	1,065
	20 x 16 x 73	500 x 400 x 1850	NNNN-B207316	1,298
	20 x 16 x 65	500 x 400 x 1659	NNNN-B206516	1,176
	20 x 16 x 57	500 x 400 x 1468	NNNN-B205716	1,152
	20 x 16 x 49	500 x 400 x 1277	NNNN-B204916	1,021

	W x D x H (in)	W x D x H (mm)	Code	All Laminate (\$)
Open bookcases with metal shelves 	<i>1 tone only. 73" H (1850 mm) - 65" H (1659 mm): 4 adjustable 15" D (375 mm) metal shelves;</i>			
	<i>57" H (1468 mm): 3 adjustable 15" D (375 mm) metal shelves;</i>			
	<i>49" H (1277 mm): 2 adjustable 15" D (375 mm) metal shelves.</i>			
	36 x 16 x 73	900 x 400 x 1850	NNNN-B367316M	2,235
	36 x 16 x 65	900 x 400 x 1659	NNNN-B366516M	2,084
	36 x 16 x 57	900 x 400 x 1468	NNNN-B365716M	1,863
	36 x 16 x 49	900 x 400 x 1277	NNNN-B364916M	1,531
	30 x 16 x 73	750 x 400 x 1850	NNNN-B307316M	2,005
	30 x 16 x 65	750 x 400 x 1659	NNNN-B306516M	1,869
	30 x 16 x 57	750 x 400 x 1468	NNNN-B305716M	1,698
	30 x 16 x 49	750 x 400 x 1277	NNNN-B304916M	1,402
	24 x 16 x 73	600 x 400 x 1850	NNNN-B247316M	1,775
	24 x 16 x 65	600 x 400 x 1659	NNNN-B246516M	1,656
	24 x 16 x 57	600 x 400 x 1468	NNNN-B245716M	1,519
	24 x 16 x 49	600 x 400 x 1277	NNNN-B244916M	1,282
	20 x 16 x 73	500 x 400 x 1850	NNNN-B207316M	1,583
	20 x 16 x 65	500 x 400 x 1659	NNNN-B206516M	1,462
	20 x 16 x 57	500 x 400 x 1468	NNNN-B205716M	1,368
	20 x 16 x 49	500 x 400 x 1277	NNNN-B204916M	1,168
	Specify the shelves finish (K, W).			

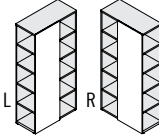
	W x D x H (in)	W x D x H (mm)	Code	All Laminate (\$)	
Open bookcases - 2 axis 	<i>Levelers allow a 3/4" (19 mm) height adjustment.</i>				
	<i>73" to 65" H (1850 to 1659 mm): 8 adjustable shelves;</i>				
	<i>57" H (1468 mm): 6 adjustable shelves;</i>				
	<i>49" H (1277 mm): 4 adjustable shelves.</i>				
	36 x 16 x 73	900 x 419 x 1850	NNN-BAB367316	2,129	
	36 x 16 x 65	900 x 419 x 1659	NNN-BAB366516	1,905	
	36 x 16 x 57	900 x 419 x 1468	NNN-BAB365716	1,689	
	36 x 16 x 49	900 x 419 x 1277	NNN-BAB364916	1,468	
	30 x 16 x 73	750 x 419 x 1850	NNN-BAB307316	2,020	
	30 x 16 x 65	750 x 419 x 1659	NNN-BAB306516	1,812	
	30 x 16 x 57	750 x 419 x 1468	NNN-BAB305716	1,604	
	30 x 16 x 49	750 x 419 x 1277	NNN-BAB304916	1,396	
	Specify left (L) or right (R). Specify the front finish (B, W, N)				

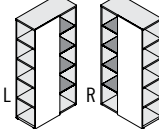
	W x D x H (in)	W x D x H (mm)	Code	All Laminate (\$)	
Open bookcases with metal shelves - 2 axis 	<i>Front metal shelves, lateral laminate shelves. Levelers allow a 3/4" (19 mm) height adjustment.</i>				
	<i>73" to 65" H (1850 to 1659 mm): 8 adjustable 15" D (375 mm) shelves, including 4 metal shelves;</i>				
	<i>57" H (1468 mm): 6 adjustable 15" D (375 mm) shelves, including 3 metal shelves;</i>				
	<i>49" H (1277 mm): 4 adjustable 15" D (375 mm) shelves, including 2 metal shelves.</i>				
	36 x 16 x 73	900 x 419 x 1850	NNN-BAB367316M	2,413	
	36 x 16 x 65	900 x 419 x 1659	NNN-BAB366516M	2,191	
	36 x 16 x 57	900 x 419 x 1468	NNN-BAB365716M	1,905	
	36 x 16 x 49	900 x 419 x 1277	NNN-BAB364916M	1,611	
	30 x 16 x 73	750 x 419 x 1850	NNN-BAB307316M	2,305	
	30 x 16 x 65	750 x 419 x 1659	NNN-BAB306516M	2,097	
	30 x 16 x 57	750 x 419 x 1468	NNN-BAB305716M	1,818	
	30 x 16 x 49	750 x 419 x 1277	NNN-BAB304916M	1,539	
	Specify left (L) or right (R). Specify the front finish (B, W, N) Specify the shelves finish (K, W).				

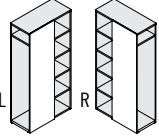
	W x D x H (in)	W x D x H (mm)	Code	All Laminate (\$)	
Bookcases with open locker - 2 axis 	<i>Wardrobe section with clothes hanger bar and 1 fixed shelf. Levelers allow a 3/4" (19 mm) height adjustment.</i>				
	<i>73" to 65" H (1850 to 1659 mm): 4 adjustable shelves;</i>				
	<i>57" H (1468 mm): 3 adjustable shelves;</i>				
	<i>49" H (1277 mm): 2 adjustable shelves.</i>				
	36 x 16 x 73	900 x 419 x 1850	NNN-CEAB367316	1,876	
	36 x 16 x 65	900 x 419 x 1659	NNN-CEAB366516	1,762	
	36 x 16 x 57	900 x 419 x 1468	NNN-CEAB365716	1,648	
	36 x 16 x 49	900 x 419 x 1277	NNN-CEAB364916	1,531	
	Specify left (L) or right (R). Specify the front finish (B, W, N)				

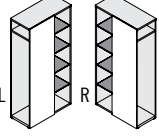
	W x D x H (in)	W x D x H (mm)	Code	All Laminate (\$)	
Bookcases with metal shelves and open locker - 2 axis 	<i>Wardrobe section with clothes hanger bar and 1 fixed shelf. Levelers allow a 3/4" (19 mm) height adjustment.</i>				
	<i>73" to 65" H (1850 to 1659 mm): 4 adjustable 15" D (375 mm) metal shelves;</i>				
	<i>57" H (1468 mm): 3 adjustable 15" D (375 mm) metal shelves;</i>				
	<i>49" H (1277 mm): 2 adjustable 15" D (375 mm) metal shelves.</i>				
	36 x 16 x 73	900 x 419 x 1850	NNN-CEAB367316M	2,162	
	36 x 16 x 65	900 x 419 x 1659	NNN-CEAB366516M	2,048	
	36 x 16 x 57	900 x 419 x 1468	NNN-CEAB365716M	1,863	
	36 x 16 x 49	900 x 419 x 1277	NNN-CEAB364916M	1,675	
	Specify left (L) or right (R). Specify the front finish (B, W, N) Specify the shelves finish (K, W).				

BOOKCASE HUTCHES				
Bookcase hutches with doors 	<i>2 doors with soft-close. Can accommodate a tackboard on its back.</i>			
	<i>52" to 36" H (1289 to 907 mm): 2 adjustable shelves;</i>			
	<i>28" H (716 mm): 1 adjustable shelf.</i>			
	36 x 20 x 52	900 x 519 x 1289	NNNN-EB365220P	2,095
	36 x 20 x 44	900 x 519 x 1098	NNNN-EB364420P	2,022
	36 x 20 x 36	900 x 519 x 907	NNNN-EB363620P	1,829
	36 x 20 x 28	900 x 519 x 716	NNNN-EB362820P	1,749
	30 x 20 x 52	750 x 519 x 1289	NNNN-EB305220P	2,038
	30 x 20 x 44	750 x 519 x 1098	NNNN-EB304420P	1,959
	30 x 20 x 36	750 x 519 x 907	NNNN-EB303620P	1,766
	30 x 20 x 28	750 x 519 x 716	NNNN-EB302820P	1,702
	36 x 16 x 52	900 x 419 x 1289	NNNN-EB365216P	2,022
	36 x 16 x 44	900 x 419 x 1098	NNNN-EB364416P	1,942
	36 x 16 x 36	900 x 419 x 907	NNNN-EB363616P	1,760
	36 x 16 x 28	900 x 419 x 716	NNNN-EB362816P	1,690
	30 x 16 x 52	750 x 419 x 1289	NNNN-EB305216P	1,942
	30 x 16 x 44	750 x 419 x 1098	NNNN-EB304416P	1,869
	30 x 16 x 36	750 x 419 x 907	NNNN-EB303616P	1,690
	30 x 16 x 28	750 x 419 x 716	NNNN-EB302816P	1,628
	Specify the fronts finish (B, W, N).			

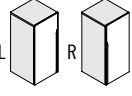
	W x D x H (in)	W x D x H (mm)	Code	All Laminate (\$)
Bookcase hutches with door 	<i>1 door with soft-close. Can accommodate a tackboard on its back.</i>			
	<i>52" to 36" H (1289 to 907 mm): 2 adjustable shelves;</i>			
	<i>28" H (716 mm): 1 adjustable shelf.</i>			
	24 x 20 x 52	600 x 519 x 1289	NNN-EB245220P	1,950
	24 x 20 x 44	600 x 519 x 1098	NNN-EB244420P	1,882
	24 x 20 x 36	600 x 519 x 907	NNN-EB243620P	1,709
	24 x 20 x 28	600 x 519 x 716	NNN-EB242820P	1,640
	20 x 20 x 52	500 x 519 x 1289	NNN-EB205220P	1,814
	20 x 20 x 44	500 x 519 x 1098	NNN-EB204420P	1,766
	20 x 20 x 36	500 x 519 x 907	NNN-EB203620P	1,597
	20 x 20 x 28	500 x 519 x 716	NNN-EB202820P	1,546
	24 x 16 x 52	600 x 419 x 1289	NNN-EB245216P	1,564
	24 x 16 x 44	600 x 419 x 1098	NNN-EB244416P	1,518
	24 x 16 x 36	600 x 419 x 907	NNN-EB243616P	1,335
	24 x 16 x 28	600 x 419 x 716	NNN-EB242816P	1,289
	16 x 16 x 52	400 x 419 x 1289	NNN-EB165216P	1,459
	16 x 16 x 44	400 x 419 x 1098	NNN-EB164416P	1,419
	16 x 16 x 36	400 x 419 x 907	NNN-EB163616P	1,256
	16 x 16 x 28	400 x 419 x 716	NNN-EB162816P	1,211
	Specify the opening: left (L) or right (R). Specify the front finish (B, W, N)			

	W x D x H (in)	W x D x H (mm)	Code	All Laminate (\$)
Open bookcase hutches 	<i>Can accommodate a tackboard on back. 1 tone only. 52" to 36" H (1289 to 907 mm): 2 adjustable shelves; 28" H (1468 mm): 1 adjustable shelf.</i>			
	36 x 20 x 52	900 x 500 x 1289	NNNNN-EB365220	1,322
	36 x 20 x 44	900 x 500 x 1098	NNNNN-EB364420	1,274
	36 x 20 x 36	900 x 500 x 907	NNNNN-EB363620	1,225
	36 x 20 x 28	900 x 500 x 716	NNNNN-EB362820	1,047
	30 x 20 x 52	750 x 500 x 1289	NNNNN-EB305220	1,264
	30 x 20 x 44	750 x 500 x 1098	NNNNN-EB304420	1,219
	30 x 20 x 36	750 x 500 x 907	NNNNN-EB303620	1,169
	30 x 20 x 28	750 x 500 x 716	NNNNN-EB302820	993
	24 x 20 x 52	600 x 500 x 1289	NNNNN-EB245220	1,201
	24 x 20 x 44	600 x 500 x 1098	NNNNN-EB244420	1,161
	24 x 20 x 36	600 x 500 x 907	NNNNN-EB243620	1,119
	24 x 20 x 28	600 x 500 x 716	NNNNN-EB242820	951
	20 x 20 x 52	500 x 500 x 1289	NNNNN-EB205220	1,176
	20 x 20 x 44	500 x 500 x 1098	NNNNN-EB204420	1,127
	20 x 20 x 36	500 x 500 x 907	NNNNN-EB203620	1,088
	20 x 20 x 28	500 x 500 x 716	NNNNN-EB202820	912
	36 x 16 x 52	900 x 400 x 1289	NNNNN-EB365216	1,232
	36 x 16 x 44	900 x 400 x 1098	NNNNN-EB364416	1,193
	36 x 16 x 36	900 x 400 x 907	NNNNN-EB363616	1,152
	36 x 16 x 28	900 x 400 x 716	NNNNN-EB362816	984
	30 x 16 x 52	750 x 400 x 1289	NNNNN-EB305216	1,182
	30 x 16 x 44	750 x 400 x 1098	NNNNN-EB304416	1,138
	30 x 16 x 36	750 x 400 x 907	NNNNN-EB303616	1,096
	30 x 16 x 28	750 x 400 x 716	NNNNN-EB302816	942
	24 x 16 x 52	600 x 400 x 1289	NNNNN-EB245216	1,127
	24 x 16 x 44	600 x 400 x 1098	NNNNN-EB244416	1,096
	24 x 16 x 36	600 x 400 x 907	NNNNN-EB243616	1,054
	24 x 16 x 28	600 x 400 x 716	NNNNN-EB242816	896
	16 x 16 x 52	400 x 400 x 1289	NNNNN-EB165216	1,096
	16 x 16 x 44	400 x 400 x 1098	NNNNN-EB164416	1,065
	16 x 16 x 36	400 x 400 x 907	NNNNN-EB163616	1,015
16 x 16 x 28	400 x 400 x 716	NNNNN-EB162816	862	

	W x D x H (in)	W x D x H (mm)	Code	All Laminate (\$)
Open bookcase hutches with metal shelves 	<i>Can accommodate a tackboard on back. 1 tone only. 52" to 36" H (1289 to 907 mm): 2 adjustable 15" D (375 mm) metal shelves; 28" H (1468 mm): 1 adjustable 15" D (375 mm) metal shelf.</i>			
	36 x 20 x 52	900 x 500 x 1289	NNNNN-EB365220M	1,756
	36 x 20 x 44	900 x 500 x 1098	NNNNN-EB364420M	1,706
	36 x 20 x 36	900 x 500 x 907	NNNNN-EB363620M	1,656
	36 x 20 x 28	900 x 500 x 716	NNNNN-EB362820M	1,259
	30 x 20 x 52	750 x 500 x 1289	NNNNN-EB305220M	1,627
	30 x 20 x 44	750 x 500 x 1098	NNNNN-EB304420M	1,576
	30 x 20 x 36	750 x 500 x 907	NNNNN-EB303620M	1,526
	30 x 20 x 28	750 x 500 x 716	NNNNN-EB302820M	1,175
	24 x 20 x 52	600 x 500 x 1289	NNNNN-EB245220M	1,490
	24 x 20 x 44	600 x 500 x 1098	NNNNN-EB244420M	1,447
	24 x 20 x 36	600 x 500 x 907	NNNNN-EB243620M	1,402
	24 x 20 x 28	600 x 500 x 716	NNNNN-EB242820M	1,096
	20 x 20 x 52	500 x 500 x 1289	NNNNN-EB205220M	1,390
	20 x 20 x 44	500 x 500 x 1098	NNNNN-EB204420M	1,346
	20 x 20 x 36	500 x 500 x 907	NNNNN-EB203620M	1,302
	20 x 20 x 28	500 x 500 x 716	NNNNN-EB202820M	1,016
	36 x 16 x 52	900 x 400 x 1289	NNNNN-EB365216M	1,588
	36 x 16 x 44	900 x 400 x 1098	NNNNN-EB364416M	1,555
	36 x 16 x 36	900 x 400 x 907	NNNNN-EB363616M	1,511
	36 x 16 x 28	900 x 400 x 716	NNNNN-EB362816M	1,160
	30 x 16 x 52	750 x 400 x 1289	NNNNN-EB305216M	1,468
	30 x 16 x 44	750 x 400 x 1098	NNNNN-EB304416M	1,426
	30 x 16 x 36	750 x 400 x 907	NNNNN-EB303616M	1,382
	30 x 16 x 28	750 x 400 x 716	NNNNN-EB302816M	1,089

	W x D x H (in)	W x D x H (mm)	Code	All Laminate (\$)
Open bookcase hutches with metal shelves (cont'd)	24 x 16 x 52	600 x 400 x 1289	NNNNN-EB245216M	1,346
	24 x 16 x 44	600 x 400 x 1098	NNNNN-EB244416M	1,309
	24 x 16 x 36	600 x 400 x 907	NNNNN-EB243616M	1,268
	24 x 16 x 28	600 x 400 x 716	NNNNN-EB242816M	1,004
	16 x 16 x 52	400 x 400 x 1289	NNNNN-EB165216M	1,239
	16 x 16 x 44	400 x 400 x 1098	NNNNN-EB164416M	1,211
	16 x 16 x 36	400 x 400 x 907	NNNNN-EB163616M	1,160
	16 x 16 x 28	400 x 400 x 716	NNNNN-EB162816M	933
Specify the shelves finish (K, W).				

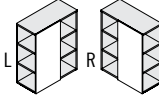
	W x D x H (in)	W x D x H (mm)	Code	All Laminate (\$)	
Open bookcase hutches - 2 axis 	<i>Can accommodate a tackboard on back. 52" to 36" H (1289 to 907 mm): 4 adjustable shelves; 28" H (1468 mm): 2 adjustable shelves.</i>				
	36 x 20 x 52	900 x 519 x 1289	NNN_-EBA365220	1,583	
	36 x 20 x 44	900 x 519 x 1098	NNN_-EBA364420	1,526	
	36 x 20 x 36	900 x 519 x 907	NNN_-EBA363620	1,475	
	36 x 20 x 28	900 x 519 x 716	NNN_-EBA362820	1,426	
	30 x 20 x 52	750 x 519 x 1289	NNN_-EBA305220	1,511	
	30 x 20 x 44	750 x 519 x 1098	NNN_-EBA304420	1,482	
	30 x 20 x 36	750 x 519 x 907	NNN_-EBA303620	1,462	
	30 x 20 x 28	750 x 519 x 716	NNN_-EBA302820	1,439	
	36 x 16 x 52	900 x 419 x 1289	NNN_-EBA365216	1,396	
	36 x 16 x 44	900 x 419 x 1098	NNN_-EBA364416	1,354	
	36 x 16 x 36	900 x 419 x 907	NNN_-EBA363616	1,302	
	36 x 16 x 28	900 x 419 x 716	NNN_-EBA362816	1,259	
	30 x 16 x 52	750 x 419 x 1289	NNN_-EBA305216	1,331	
	30 x 16 x 44	750 x 419 x 1098	NNN_-EBA304416	1,309	
	30 x 16 x 36	750 x 419 x 907	NNN_-EBA303616	1,296	
	30 x 16 x 28	750 x 419 x 716	NNN_-EBA302816	1,275	
	Specify left (L) or right (R). Specify the front finish (B, W, N)				

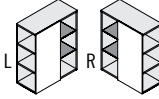
	W x D x H (in)	W x D x H (mm)	Code	All Laminate (\$)	
Open bookcase hutches with metal shelves - 2 axis 	<i>Front metal shelves, lateral laminate shelves. Can accommodate a tackboard on back. 52" to 36" H (1289 to 907 mm): 4 adjustable 15" D (375 mm) shelves, including 2 in metal; 28" H (1468 mm): 2 adjustable 15" D (375 mm) shelves, including 1 metal shelf.</i>				
	36 x 20 x 52	900 x 519 x 1289	NNN_-EBA365220M	1,726	
	36 x 20 x 44	900 x 519 x 1098	NNN_-EBA364420M	1,669	
	36 x 20 x 36	900 x 519 x 907	NNN_-EBA363620M	1,620	
	36 x 20 x 28	900 x 519 x 716	NNN_-EBA362820M	1,496	
	30 x 20 x 52	750 x 519 x 1289	NNN_-EBA305220M	1,656	
	30 x 20 x 44	750 x 519 x 1098	NNN_-EBA304420M	1,627	
	30 x 20 x 36	750 x 519 x 907	NNN_-EBA303620M	1,604	
	30 x 20 x 28	750 x 519 x 716	NNN_-EBA302820M	1,511	
	36 x 16 x 52	900 x 419 x 1289	NNN_-EBA365216M	1,539	
	36 x 16 x 44	900 x 419 x 1098	NNN_-EBA364416M	1,496	
	36 x 16 x 36	900 x 419 x 907	NNN_-EBA363616M	1,447	
	36 x 16 x 28	900 x 419 x 716	NNN_-EBA362816M	1,331	
	30 x 16 x 52	750 x 419 x 1289	NNN_-EBA305216M	1,475	
	30 x 16 x 44	750 x 419 x 1098	NNN_-EBA304416M	1,453	
	30 x 16 x 36	750 x 419 x 907	NNN_-EBA303616M	1,439	
	30 x 16 x 28	750 x 419 x 716	NNN_-EBA302816M	1,346	
	Specify left (L) or right (R). Specify the front finish (B, W, N) Specify the shelves finish (K, W).				

2-TONE LAMINATE APPLICATION: SHADED AREA CORRESPONDS TO THE FIRST CODE TO BE SPECIFIED. SECOND LAMINATE CODE WILL BE APPLIED TO THE REST OF THE PRODUCT.

W x D x H (in)	W x D x H (mm)	Code	All Laminate (\$)
Open bookcase hutches with sliding door			
<i>Sliding door. Can accommodate a tackboard on back. 52" to 36" H (1289 to 907 mm): 4 adjustable shelves; 28" H (716 mm): 2 adjustable shelves.</i>			
36 x 20 x 52	900 x 519 x 1289	NNNN -EB365220C	2,081
36 x 20 x 44	900 x 519 x 1098	NNNN -EB364420C	2,008
36 x 20 x 36	900 x 519 x 907	NNNN -EB363620C	1,942
36 x 20 x 28	900 x 519 x 716	NNNN -EB362820C	1,772
30 x 20 x 52	750 x 519 x 1289	NNNN -EB305220C	1,988
30 x 20 x 44	750 x 519 x 1098	NNNN -EB304420C	1,934
30 x 20 x 36	750 x 519 x 907	NNNN -EB303620C	1,869
30 x 20 x 28	750 x 519 x 716	NNNN -EB302820C	1,716
36 x 16 x 52	900 x 419 x 1289	NNNN -EB365216C	2,001
36 x 16 x 44	900 x 419 x 1098	NNNN -EB364416C	1,942
36 x 16 x 36	900 x 419 x 907	NNNN -EB363616C	1,877
36 x 16 x 28	900 x 419 x 716	NNNN -EB362816C	1,716
30 x 16 x 52	750 x 419 x 1289	NNNN -EB305216C	1,934
30 x 16 x 44	750 x 419 x 1098	NNNN -EB304416C	1,869
30 x 16 x 36	750 x 419 x 907	NNNN -EB303616C	1,814
30 x 16 x 28	750 x 419 x 716	NNNN -EB302816C	1,660

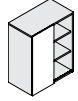

High-Gloss Black (B) or High-Gloss White (W) front finish option: add \$242.

W x D x H (in)	W x D x H (mm)	Code	All Laminate (\$)
Hutches with open bookcase and sliding door - 44" H			
<i>Open spaces on top: 13 3/4" H (348 mm). Sliding door. Height clearance: 12 3/4" (325 mm). Full-width wire access. Can accommodate a tackboard.</i>			
72 x 16 x 44	1800 x 419 x 1098	NNNN -EN724416C	2,020
66 x 16 x 44	1650 x 419 x 1098	NNNN -EN664416C	1,977
60 x 16 x 44	1500 x 419 x 1098	NNNN -EN604416C	1,926
54 x 16 x 44	1350 x 419 x 1098	NNNN -EN544416C	1,881

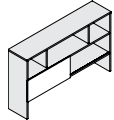

High-Gloss Black (B) or High-Gloss White (W) front finish option: add \$160.

W x D x H (in)	W x D x H (mm)	Code	All Laminate (\$)
Hutches with open spaces and sliding door - 36" H			
<i>Open spaces on top: 6" H (157 mm). Sliding door. Height clearance: 12 3/4" (325 mm). Full-width wire access. Can accommodate a tackboard.</i>			
72 x 16 x 36	1800 x 419 x 907	NNNN -EN723616C	1,942
66 x 16 x 36	1650 x 419 x 907	NNNN -EN663616C	1,899
60 x 16 x 36	1500 x 419 x 907	NNNN -EN603616C	1,854
54 x 16 x 36	1350 x 419 x 907	NNNN -EN543616C	1,812

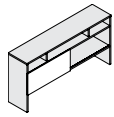

High-Gloss Black (B) or High-Gloss White (W) front finish option: add \$160.

MEDIA PANELS

W x D x H (in)	W x D x H (mm)	Code	All Laminate (\$)
Media panels for storage modules 21" H			
<i>Openings on left and on right. Can accommodate a non-articulated flat screen support (sold separately). Grommets for wire management. Must be used with 21" H (561 mm) storage module. 1 tone only.</i>			
<i>73" H (1837 mm): 2 fixed shelves; 65" to 57" H (1646 to 1455 mm): 1 fixed shelf.</i>			
48 x 7 x 73	1200 x 185 x 1837	NNNN -ETV487321	1,775
42 x 7 x 73	1050 x 185 x 1837	NNNN -ETV427321	1,698
36 x 7 x 73	900 x 185 x 1837	NNNN -ETV367321	1,627
48 x 7 x 65	1200 x 185 x 1646	NNNN -ETV486521	1,611
42 x 7 x 65	1050 x 185 x 1646	NNNN -ETV426521	1,539
36 x 7 x 65	900 x 185 x 1646	NNNN -ETV366521	1,475
48 x 7 x 57	1200 x 185 x 1455	NNNN -ETV485721	1,447
42 x 7 x 57	1050 x 185 x 1455	NNNN -ETV425721	1,382
36 x 7 x 57	900 x 185 x 1455	NNNN -ETV365721	1,325

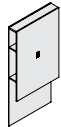

W x D x H (in)	W x D x H (mm)	Code	All Laminate (\$)
Media panels for storage modules 27" H			
<i>Openings on left and on right. Can accommodate a non-articulated flat screen support (sold separately). Grommets for wire management. Must be used with 27" H (690 mm) storage module. 1 tone only.</i>			
<i>71" H (1775 mm): 2 fixed shelves; 63" to 55" H (1584 to 1393 mm): 1 fixed shelf.</i>			
48 x 7 x 71	1200 x 185 x 1775	NNNN -ETV487127	1,762
42 x 7 x 71	1050 x 185 x 1775	NNNN -ETV427127	1,689
36 x 7 x 71	900 x 185 x 1775	NNNN -ETV367127	1,620
48 x 7 x 63	1200 x 185 x 1584	NNNN -ETV486327	1,597
42 x 7 x 63	1050 x 185 x 1584	NNNN -ETV426327	1,526
36 x 7 x 63	900 x 185 x 1584	NNNN -ETV366327	1,462
48 x 7 x 55	1200 x 185 x 1393	NNNN -ETV485527	1,426
42 x 7 x 55	1050 x 185 x 1393	NNNN -ETV425527	1,368
36 x 7 x 55	900 x 185 x 1393	NNNN -ETV365527	1,302

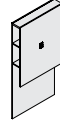

W x D x H (in)	W x D x H (mm)	Code	All Laminate (\$)
Media panels for desks and tables 29 1/2" H			
<i>Openings on left and on right. Can accommodate a non-articulated flat screen support (sold separately). Grommets for wire management. Must be used with a 29 1/2" H (752 mm) desk or table. 1 tone only.</i>			
<i>73" H (1837 mm): 2 fixed shelves; 65" to 57" H (1646 to 1455 mm): 1 fixed shelf.</i>			
48 x 7 x 73	1200 x 185 x 1837	NNNN -ETV487329	1,756
42 x 7 x 73	1050 x 185 x 1837	NNNN -ETV427329	1,683
36 x 7 x 73	900 x 185 x 1837	NNNN -ETV367329	1,611
48 x 7 x 65	1200 x 185 x 1646	NNNN -ETV486529	1,583
42 x 7 x 65	1050 x 185 x 1646	NNNN -ETV426529	1,519
36 x 7 x 65	900 x 185 x 1646	NNNN -ETV366529	1,453
48 x 7 x 57	1200 x 185 x 1455	NNNN -ETV485729	1,402
42 x 7 x 57	1050 x 185 x 1455	NNNN -ETV425729	1,346
36 x 7 x 57	900 x 185 x 1455	NNNN -ETV365729	1,289

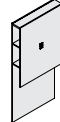

WALL-MOUNTED HUTCHES

W x D x H (in)	W x D x H (mm)	Code	All Laminate (\$)
Wall-mounted hutches with lift-up door and open space on right			
<i>Assisted lift-up door with soft close. Open space on right. Assembly hardware included for wall-mount installation.</i>			
<i>72" W (1800 mm): 26" W (645 mm) open bookcase; 66" W (1650 mm): 22" W (545 mm) open bookcase; 60" W (1500 mm): 20" W (495 mm) open bookcase; 54" W (1350 mm): 18" W (445 mm) open bookcase.</i>			
72 x 16 x 16	1800 x 419 x 400	NNN -EMV721616	1,669
66 x 16 x 16	1650 x 419 x 400	NNN -EMV661616	1,635
60 x 16 x 16	1500 x 419 x 400	NNN -EMV601616	1,597
54 x 16 x 16	1350 x 419 x 400	NNN -EMV541616	1,557
<i>Specify the handle curve: double (D), left (L) or right (R). Specify the front finish (B, W, N).</i>			

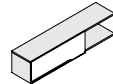

High-Gloss Black (B) or High-Gloss White (W) front finish option: add \$160.

W x D x H (in)	W x D x H (mm)	Code	All Laminate (\$)
Wall-mounted hutches with lift-up door and open space on left			
<i>Assisted lift-up door with soft close. Open space on left. Assembly hardware included for wall-mount installation.</i>			
<i>72" W (1800 mm): 26" W (645 mm) open bookcase; 66" W (1650 mm): 22" W (545 mm) open bookcase; 60" W (1500 mm): 20" W (495 mm) open bookcase; 54" W (1350 mm): 18" W (445 mm) open bookcase.</i>			
72 x 16 x 16	1800 x 419 x 400	NNN -EM721616V	1,669
66 x 16 x 16	1650 x 419 x 400	NNN -EM661616V	1,635
60 x 16 x 16	1500 x 419 x 400	NNN -EM601616V	1,597
54 x 16 x 16	1350 x 419 x 400	NNN -EM541616V	1,557
<i>Specify the handle curve: double (D), left (L) or right (R). Specify the front finish (B, W, N).</i>			

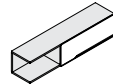

High-Gloss Black (B) or High-Gloss White (W) front finish option: add \$160.

W x D x H (in)	W x D x H (mm)	Code	All Laminate (\$)
Wall-mounted hutches with sliding door			
<i>Sliding door. Assembly hardware included for wall-mount installation. Can accommodate a tackboard.</i>			
84 x 16 x 16	2100 x 419 x 400	NNNN -EM841616C	1,690
78 x 16 x 16	1950 x 419 x 400	NNNN -EM781616C	1,654
72 x 16 x 16	1800 x 419 x 400	NNNN -EM721616C	1,612
66 x 16 x 16	1650 x 419 x 400	NNNN -EM661616C	1,572
60 x 16 x 16	1500 x 419 x 400	NNNN -EM601616C	1,538
54 x 16 x 16	1350 x 419 x 400	NNNN -EM541616C	1,499
<i>Specify the front finish (B, W, N).</i>			

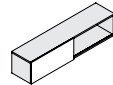

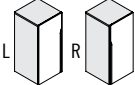

High-Gloss Black (B) or High-Gloss White (W) front finish option: add \$160.

	W x D x H (in)	W x D x H (mm)	Code	All Laminate (\$)
Wall-mounted hutches with doors  High-Gloss Black (B) or High-Gloss White (W) fronts finish option: add \$160.	2 doors with soft close. Assembly hardware included for wall-mount installation. 52" to 36" H (1289 to 907 mm); 2 adjustable shelves; 28" H (716 mm); 1 adjustable shelf.			
	36 x 16 x 52	900 x 419 x 1289	NNNN -EM365216P	1,934
	36 x 16 x 44	900 x 419 x 1098	NNNN -EM364416P	1,838
	36 x 16 x 36	900 x 419 x 907	NNNN -EM363616P	1,702
	36 x 16 x 28	900 x 419 x 716	NNNN -EM362816P	1,635
	30 x 16 x 52	750 x 419 x 1289	NNNN -EM305216P	1,863
	30 x 16 x 44	750 x 419 x 1098	NNNN -EM304416P	1,772
	30 x 16 x 36	750 x 419 x 907	NNNN -EM303616P	1,640
	30 x 16 x 28	750 x 419 x 716	NNNN -EM302816P	1,585
	Specify the fronts finish (B, W, N).			

	W x D x H (in)	W x D x H (mm)	Code	All Laminate (\$)
Wall-mounted hutches with door  High-Gloss Black (B) or High-Gloss White (W) front finish option: add \$122.	1 door with soft close. Assembly hardware included for wall-mount installation. 52" to 36" H (1289 to 907 mm); 2 adjustable shelves; 28" H (716 mm); 1 adjustable shelf.			
	24 x 16 x 52	600 x 419 x 1289	NNN -EM245216P	1,732
	24 x 16 x 44	600 x 419 x 1098	NNN -EM244416P	1,654
	24 x 16 x 36	600 x 419 x 907	NNN -EM243616P	1,530
	24 x 16 x 28	600 x 419 x 716	NNN -EM242816P	1,490
Specify the opening: left (L) or right (R). Specify the front finish (B, W, N).				

PEDESTALS				
Hanging pedestal with drawers  High-Gloss Black (B) or High-Gloss White (W) front finish option: add \$81.	1 box drawer and 1 file drawer with soft-close. Suspension bar. Pencil tray. Lock. Must be installed under a surface. Not compatible with 20" (500 mm) deep surfaces and height adjustable desks.			
	16 x 18 x 20	409 x 448 x 489	NNN -161820F	1,225
	Specify the handle curve: double (D), left (L) or right (R). Specify the fronts finish (B, W, N).			

Mobile pedestal with drawers  High-Gloss Black (B) or High-Gloss White (W) front finish option: add \$81.	1 box drawer and 1 file drawer with soft-close. Suspension bar. Pencil tray. Lock. Brakes on front casters. Can accommodate 1 cushion.			
	16 x 18 x 20	390 x 450 x 530	NNN -MP161820F	1,506
Specify the handle curve: double (D), left (L) or right (R). Specify the fronts finish (B, W, N).				

ACCESSORIES				
Modular modesty panels for short back surfaces  High-Gloss Black (B) or High-Gloss White (W) front finish option: 27" to 51" W (669 to 1269 mm): add \$122; 55" to 67" W (1369 to 1669 mm): add \$160; 69" to 81" W (1719 to 2019 mm): add \$203.	Use as a modesty panel under 6" H (150 mm) short-back surfaces. Not compatible with struts surfaces, return-surfaces and desks with height adjustable returns. 1 tone only.			
	81 x 5/8 x 14	2019 x 16 x 350	NNNN -MOD1481	306
	75 x 5/8 x 14	1869 x 16 x 350	NNNN -MOD1475	298
	73 x 5/8 x 14	1819 x 16 x 350	NNNN -MOD1473	298
	69 x 5/8 x 14	1719 x 16 x 350	NNNN -MOD1469	290
	67 x 5/8 x 14	1669 x 16 x 350	NNNN -MOD1467	290
	63 x 5/8 x 14	1569 x 16 x 350	NNNN -MOD1463	283
	61 x 5/8 x 14	1519 x 16 x 350	NNNN -MOD1461	283
	57 x 5/8 x 14	1419 x 16 x 350	NNNN -MOD1457	265
	55 x 5/8 x 14	1369 x 16 x 350	NNNN -MOD1455	256
	51 x 5/8 x 14	1269 x 16 x 350	NNNN -MOD1451	256
	49 x 5/8 x 14	1219 x 16 x 350	NNNN -MOD1449	250
	45 x 5/8 x 14	1119 x 16 x 350	NNNN -MOD1445	250
	39 x 5/8 x 14	969 x 16 x 350	NNNN -MOD1439	242
	33 x 5/8 x 14	819 x 16 x 350	NNNN -MOD1433	235
27 x 5/8 x 14	669 x 16 x 350	NNNN -MOD1427	235	
Specify the modesty panel finish (B, W, N).				

	W x D x H (in)	W x D x H (mm)	Code	All Laminate (\$)
Modular modesty panels for surfaces with struts  High-Gloss Black (B) or High-Gloss White (W) front finish option: 27" to 51" W (669 to 1269 mm): add \$122; 55" to 67" W (1369 to 1669 mm): add \$160; 69" to 81" W (1719 to 2019 mm): add \$203.	To be used as a modesty panel underneath surfaces with struts, return tables and electric desks with return. Not compatible with 6" H (150 mm) short-back surfaces. 1 tone only.			
	69 x 5/8 x 14	1719 x 16 x 350	NNNN -MODS1469	306
	67 x 5/8 x 14	1669 x 16 x 350	NNNN -MODS1467	298
	63 x 5/8 x 14	1569 x 16 x 350	NNNN -MODS1463	298
	61 x 5/8 x 14	1519 x 16 x 350	NNNN -MODS1461	290
	57 x 5/8 x 14	1419 x 16 x 350	NNNN -MODS1457	290
	55 x 5/8 x 14	1369 x 16 x 350	NNNN -MODS1455	283
	51 x 5/8 x 14	1269 x 16 x 350	NNNN -MODS1451	283
	49 x 5/8 x 14	1219 x 16 x 350	NNNN -MODS1449	265
	45 x 5/8 x 14	1119 x 16 x 350	NNNN -MODS1445	256
	39 x 5/8 x 14	969 x 16 x 350	NNNN -MODS1439	256
	33 x 5/8 x 14	819 x 16 x 350	NNNN -MODS1433	250
	27 x 5/8 x 14	669 x 16 x 350	NNNN -MODS1427	250
Specify the modesty panel finish (B, W, N).				

	W x D x H (in)	W x D x H (mm)	Code	All Laminate (\$)
Fabric privacy lateral screens  Fabric screen supported by metal clips. Height adjustable. Can be attached to a surface, desk or return. These prices are applicable for United Chair® Grade 1 and 2 fabrics. For other United Chair® grades add: Grade 3: 15%, Grade 4: 20%, Grade 5: 25%, Grade 6: 30%, Grade 8: 35%.	Fabric screen supported by metal clips. Height adjustable. Can be attached to a surface, desk or return. These prices are applicable for United Chair® Grade 1 and 2 fabrics. For other United Chair® grades add: Grade 3: 15%, Grade 4: 20%, Grade 5: 25%, Grade 6: 30%, Grade 8: 35%.			
	48 x 3/4 x 30	1200 x 19 x 750	NNNN -SCF3048	805
	42 x 3/4 x 30	1050 x 19 x 750	NNNN -SCF3042	779
	36 x 3/4 x 30	900 x 19 x 750	NNNN -SCF3036	758
	30 x 3/4 x 30	750 x 19 x 750	NNNN -SCF3030	731
	48 x 3/4 x 24	1200 x 19 x 600	NNNN -SCF2448	766
	42 x 3/4 x 24	1050 x 19 x 600	NNNN -SCF2442	752
	36 x 3/4 x 24	900 x 19 x 600	NNNN -SCF2436	724
	30 x 3/4 x 24	750 x 19 x 600	NNNN -SCF2430	701
	24 x 3/4 x 24	600 x 19 x 600	NNNN -SCF2424	677

Acrylic privacy lateral screens  Translucent screen supported by metal clips. Height adjustable. Can be attached to a surface, desk or return.	Translucent screen supported by metal clips. Height adjustable. Can be attached to a surface, desk or return.			
	48 x 1/4 x 30	1200 x 6 x 750	NNNN -SCT3048	1,071
	42 x 1/4 x 30	1050 x 6 x 750	NNNN -SCT3042	960
	36 x 1/4 x 30	900 x 6 x 750	NNNN -SCT3036	847
	30 x 1/4 x 30	750 x 6 x 750	NNNN -SCT3030	731
	48 x 1/4 x 24	1200 x 6 x 600	NNNN -SCT2448	896
	42 x 1/4 x 24	1050 x 6 x 600	NNNN -SCT2442	798
	36 x 1/4 x 24	900 x 6 x 600	NNNN -SCT2436	718
	30 x 1/4 x 24	750 x 6 x 600	NNNN -SCT2430	620
	24 x 1/4 x 24	600 x 6 x 600	NNNN -SCT2424	532

Tackboards for hutches with sliding door 	These prices are applicable for United Chair® Grade 1 and 2 fabrics. For other United Chair® grades add: Grade 3: 15%, Grade 4: 20%, Grade 5: 25%, Grade 6: 30%, Grade 8: 35%.			
	70 x 1/2 x 12	1750 x 13 x 279	NNNN -TK7012E	524
	64 x 1/2 x 12	1600 x 13 x 279	NNNN -TK6412E	510
	58 x 1/2 x 12	1450 x 13 x 279	NNNN -TK5812E	493
	52 x 1/2 x 12	1300 x 13 x 279	NNNN -TK5212E	480

Tackboards for the back of bookcase hutches 	These prices are applicable for United Chair® Grade 1 and 2 fabrics. For other United Chair® grades add: Grade 3: 15%, Grade 4: 20%, Grade 5: 25%, Grade 6: 30%, Grade 8: 35%.			
	34 x 1/2 x 50	841 x 13 x 1232	NNNN -TK3450	570
	34 x 1/2 x 42	841 x 13 x 1041	NNNN -TK3442	556
	34 x 1/2 x 34	841 x 13 x 850	NNNN -TK3434	540
	34 x 1/2 x 26	841 x 13 x 659	NNNN -TK3426	525
	28 x 1/2 x 50	691 x 13 x 1232	NNNN -TK2850	556
	28 x 1/2 x 42	691 x 13 x 1041	NNNN -TK2842	540
	28 x 1/2 x 34	691 x 13 x 850	NNNN -TK2834	525
	28 x 1/2 x 26	691 x 13 x 659	NNNN -TK2826	510
	22 x 1/2 x 50	541 x 13 x 1232	NNNN -TK2250	540
	22 x 1/2 x 42	541 x 13 x 1041	NNNN -TK2242	525
	22 x 1/2 x 34	541 x 13 x 850	NNNN -TK2234	510
	22 x 1/2 x 26	541 x 13 x 659	NNNN -TK2226	484
	18 x 1/2 x 50	441 x 13 x 1232	NNNN -TK1850	525
	18 x 1/2 x 42	441 x 13 x 1041	NNNN -TK1842	510
	18 x 1/2 x 34	441 x 13 x 850	NNNN -TK1834	484
	18 x 1/2 x 26	441 x 13 x 659	NNNN -TK1826	469
	14 x 1/2 x 50	341 x 13 x 1232	NNNN -TK1450	510
	14 x 1/2 x 42	341 x 13 x 1041	NNNN -TK1442	484
	14 x 1/2 x 34	341 x 13 x 850	NNNN -TK1434	469
	14 x 1/2 x 26	341 x 13 x 659	NNNN -TK1426	451

All
Laminate
(\$)

Cushions



W x D x H (in) W x D x H (mm) Code

1 3/8" (35 mm) thick cushion. Installs on low storage modules and benches with Velcro. These prices are applicable for United Chair® Grade 1 and 2 fabrics. For other United Chair® grades add: Grade 3: 15%, Grade 4: 20%, Grade 5: 25%, Grade 6: 30%, Grade 7: 35%.

For storage modules

48 x 36 x 1 3/8	1200 x 900 x 35	NNNNN-CU3648	960
42 x 36 x 1 3/8	1250 x 900 x 35	NNNNN-CU3642	896
36 x 36 x 1 3/8	900 x 900 x 35	NNNNN-CU3636	831
30 x 36 x 1 3/8	750 x 900 x 35	NNNNN-CU3630	759
24 x 36 x 1 3/8	600 x 900 x 35	NNNNN-CU3624	694
16 x 36 x 1 3/8	400 x 900 x 35	NNNNN-CU3616	630
48 x 30 x 1 3/8	1200 x 750 x 35	NNNNN-CU3048	870
42 x 30 x 1 3/8	1250 x 750 x 35	NNNNN-CU3042	824
36 x 30 x 1 3/8	900 x 750 x 35	NNNNN-CU3036	779
30 x 30 x 1 3/8	750 x 750 x 35	NNNNN-CU3030	717
24 x 30 x 1 3/8	600 x 750 x 35	NNNNN-CU3024	653
16 x 30 x 1 3/8	400 x 750 x 35	NNNNN-CU3016	587
48 x 24 x 1 3/8	1200 x 600 x 35	NNNNN-CU2448	779
42 x 24 x 1 3/8	1250 x 600 x 35	NNNNN-CU2442	737
36 x 24 x 1 3/8	900 x 600 x 35	NNNNN-CU2436	694
30 x 24 x 1 3/8	750 x 600 x 35	NNNNN-CU2430	630
24 x 24 x 1 3/8	600 x 600 x 35	NNNNN-CU2424	563
16 x 24 x 1 3/8	400 x 600 x 35	NNNNN-CU2416	493
48 x 20 x 1 3/8	1200 x 500 x 35	NNNNN-CU2048	742
42 x 20 x 1 3/8	1250 x 500 x 35	NNNNN-CU2042	680
36 x 20 x 1 3/8	900 x 500 x 35	NNNNN-CU2036	620
30 x 20 x 1 3/8	750 x 500 x 35	NNNNN-CU2030	558
24 x 20 x 1 3/8	600 x 500 x 35	NNNNN-CU2024	490
16 x 20 x 1 3/8	400 x 500 x 35	NNNNN-CU2016	423

For benches

48 x 18 x 1 3/8	1200 x 450 x 35	NNNNN-CU1848	717
42 x 18 x 1 3/8	1050 x 450 x 35	NNNNN-CU1842	659
36 x 18 x 1 3/8	900 x 450 x 35	NNNNN-CU1836	603
32 x 18 x 1 3/8	800 x 450 x 35	NNNNN-CU1832	580
30 x 18 x 1 3/8	750 x 450 x 35	NNNNN-CU1830	557
28 x 18 x 1 3/8	700 x 450 x 35	NNNNN-CU1828	534
26 x 18 x 1 3/8	650 x 450 x 35	NNNNN-CU1826	513
24 x 18 x 1 3/8	600 x 450 x 35	NNNNN-CU1824	489
22 x 18 x 1 3/8	550 x 450 x 35	NNNNN-CU1822	469
20 x 18 x 1 3/8	500 x 450 x 35	NNNNN-CU1820	446
18 x 18 x 1 3/8	450 x 450 x 35	NNNNN-CU1818	424
16 x 18 x 1 3/8	400 x 450 x 35	NNNNN-CU1816	401

For pedestal

15 x 18 x 1 3/8	388 x 430 x 35	NNNNN-CU1518	392
-----------------	----------------	--------------	-----

Grommets



Metal grommet. Satin chrome finish.

LGC-MGRQ25	89
LGC-MGRQ38	89

Wireless charger



Compatible with any Qi rated devices and smartphones. Black tempered glass surface and stainless steel frame. 78" (1981 mm) cord included. The transformer is UL and CUL certified. Field installation, 3 1/8" H (79 mm)

3 1/2 x 3 1/2 x 1	88 x 88 x 25	LGC-CHARGE	729
-------------------	--------------	------------	-----