

A banner image showing a modern office interior with a desk, chair, and shelving units. The text 'LACASSE OFFICE FURNITURE' is prominently displayed in the center.

LACASSE OFFICE FURNITURE

CALL 201-254-0145 | HALF PRICE SALE ON NOW

LacasseOfficeFurniture.com 201-254-0145

Groupe Lacasse Half Price Sale On Now

Take Half Off the List Prices in this PDF

Call 201-254-0145 Now

Free Layout & Design Service

Concept 70 Series



CONCEPT 70

EDGEBANDING

Furniture with 1½" (38 mm) thick tops.

N Edge

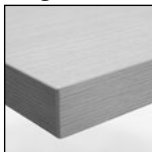

Smooth, ¼" (1,5 mm) thick edge.

The N edge is **matched with the finish specified for the surface.**

Textured 1 Edge

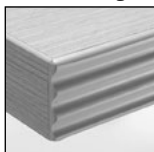

Textured, ¼" (3 mm) thick edge.

The textured 1 and 2 edges are **available (and in matching color) ONLY when a ATH, BUC, CCL, CER, ERH, HRG, HZN, RAS, SAH or TOM wood grain finish is specified for the surface.**

Textured 2 Edge

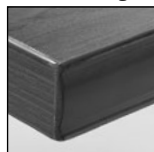

HANDLES

A choice of two metal handles offered in three colors.



DA Anthracite Grey

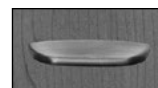

DB Brass

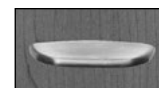

DN Nickel



KA Anthracite Grey



KB Brass



KN Nickel

CODIFICATION

Series	Options		
	Edgbanding	Handles	Accent color
7	N Smooth edge 1 Textured 1 edge 2 Textured 2 edge	D Straight K Classic	A Anthracite Grey B Brass N Nickel

LACASSE QUICKSHIP PROGRAM*

Products and suggested layouts identified by this pictogram are part of the Lacasse quick delivery program.

Please refer to page 3 for complete program details.

* Due to current market conditions, always refer to our Lead-Time Guide for a confirmation of our current Lacasse QuickShip lead-times.



	W x D x H (in)	W x D x H (mm)	Code	Price (\$)
	<i>2 pedestals with locks, 2 box drawers and 2 file drawers with suspension bars. Pencil tray. Recessed, full-height modesty panel.</i>			
	84 x 36 x 29½	2100 x 900 x 748	7___-F3684F	2,571
	72 x 36 x 29½	1800 x 900 x 748	7___-F3672F	2,410
	72 x 30 x 29½	1800 x 750 x 748	7___-F3072F	2,329
	66 x 30 x 29½	1650 x 750 x 748	7___-F3066F	2,257
	60 x 30 x 29½	1500 x 750 x 748	7___-F3060F	2,184
Specify the edge (N, 1, 2). Specify the handle code (D, K). Specify the accent color (A, B, N).				

	W x D x H (in)	W x D x H (mm)	Code	Price (\$)
	<i>2 pedestals with locks, 2 box drawers and 2 file drawers with suspension bars. Pencil tray. Recessed, full-height modesty panel.</i>			
	84 x 42 x 29½	2100 x 1050 x 748	7___-F4284FA	2,991
	72 x 42 x 29½	1800 x 1050 x 748	7___-F4272FA	2,739
Specify the edge (N, 1, 2). Specify the handle code (D, K). Specify the accent color (A, B, N).				

	W x D x H (in)	W x D x H (mm)	Code	Price (\$)
	<i>1 pedestal on left with lock, 1 box drawer and 1 file drawer with suspension bar. Pencil tray. Recessed, full-height modesty panel.</i>			
	84 x 36 x 29½	2100 x 900 x 748	7___-F3684S	2,081
	72 x 36 x 29½	1800 x 900 x 748	7___-F3672S	1,910
	72 x 30 x 29½	1800 x 750 x 748	7___-F3072S	1,838
	66 x 30 x 29½	1650 x 750 x 748	7___-F3066S	1,760
	60 x 30 x 29½	1500 x 750 x 748	7___-F3060S	1,684
	48 x 30 x 29½	1200 x 750 x 748	7___-F3048S	1,578
Specify the edge (N, 1, 2). Specify the handle code (D, K). Specify the accent color (A, B, N).				

	W x D x H (in)	W x D x H (mm)	Code	Price (\$)
	<i>1 pedestal on right with lock, 1 box drawer and 1 file drawer with suspension bar. Pencil tray. Recessed, full-height modesty panel.</i>			
	84 x 36 x 29½	2100 x 900 x 748	7___-S3684F	2,081
	72 x 36 x 29½	1800 x 900 x 748	7___-S3672F	1,910
	72 x 30 x 29½	1800 x 750 x 748	7___-S3072F	1,838
	66 x 30 x 29½	1650 x 750 x 748	7___-S3066F	1,760
	60 x 30 x 29½	1500 x 750 x 748	7___-S3060F	1,684
	48 x 30 x 29½	1200 x 750 x 748	7___-S3048F	1,578
Specify the edge (N, 1, 2). Specify the handle code (D, K). Specify the accent color (A, B, N).				

	W x D x H (in)	W x D x H (mm)	Code	Price (\$)
	<i>1 pedestal on left with lock, 1 box drawer and 1 file drawer with suspension bar. Pencil tray. Recessed, full-height modesty panel.</i>			
	84 x 42 x 29½	2100 x 1050 x 748	7___-F4284SA	2,571
	72 x 42 x 29½	1800 x 1050 x 748	7___-F4272SA	2,410
Specify the edge (N, 1, 2). Specify the handle code (D, K). Specify the accent color (A, B, N).				

	W x D x H (in)	W x D x H (mm)	Code	Price (\$)
	<i>1 pedestal on right with lock, 1 box drawer and 1 file drawer with suspension bar. Pencil tray. Recessed, full-height modesty panel.</i>			
	84 x 42 x 29½	2100 x 1050 x 748	7___-S4284FA	2,571
	72 x 42 x 29½	1800 x 1050 x 748	7___-S4272FA	2,410
Specify the edge (N, 1, 2). Specify the handle code (D, K). Specify the accent color (A, B, N).				

	W x D x H (in)	W x D x H (mm)	Code	Price (\$)
	<i>2 pedestals with locks, 4 box drawers and 2 file drawers with suspension bars. Pencil tray. Recessed, full-height modesty panel.</i>			
	84 x 36 x 29½	2100 x 900 x 748	7___-UF3684UF	3,070
	72 x 36 x 29½	1800 x 900 x 748	7___-UF3672UF	2,909
	72 x 30 x 29½	1800 x 750 x 748	7___-UF3072UF	2,829
	66 x 30 x 29½	1650 x 750 x 748	7___-UF3066UF	2,755
	60 x 30 x 29½	1500 x 750 x 748	7___-UF3060UF	2,683
Specify the edge (N, 1, 2). Specify the handle code (D, K). Specify the accent color (A, B, N).				

	W x D x H (in)	W x D x H (mm)	Code	Price (\$)
Double pedestal bow front desks – low profile	<i>2 pedestals with locks, 4 box drawers and 2 file drawers with suspension bars. Pencil tray. Recessed, full-height modesty panel.</i>			
	84 x 42 x 29½	2100 x 1050 x 748	7___-UF4284UFA	3,440
	72 x 42 x 29½	1800 x 1050 x 748	7___-UF4272UFA	3,281

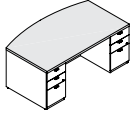

	W x D x H (in)	W x D x H (mm)	Code	Price (\$)
Left single pedestal desks – low profile	<i>1 pedestal on left with lock, 2 box drawers and 1 file drawer with suspension bar. Pencil tray. Recessed, full-height modesty panel.</i>			
	84 x 36 x 29½	2100 x 900 x 748	7___-UF3684S	2,322
	72 x 36 x 29½	1800 x 900 x 748	7___-UF3672S	2,161
	72 x 30 x 29½	1800 x 750 x 748	7___-UF3072S	2,087
	66 x 30 x 29½	1650 x 750 x 748	7___-UF3066S	2,008
	60 x 30 x 29½	1500 x 750 x 748	7___-UF3060S	1,934
	48 x 30 x 29½	1200 x 750 x 748	7___-UF3048S	1,829

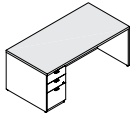

	W x D x H (in)	W x D x H (mm)	Code	Price (\$)
Right single pedestal desks – low profile	<i>1 pedestal on right with lock, 2 box drawers and 1 file drawer with suspension bar. Pencil tray. Recessed, full-height modesty panel.</i>			
	84 x 36 x 29½	2100 x 900 x 748	7___-S3684UF	2,322
	72 x 36 x 29½	1800 x 900 x 748	7___-S3672UF	2,161
	72 x 30 x 29½	1800 x 750 x 748	7___-S3072UF	2,087
	66 x 30 x 29½	1650 x 750 x 748	7___-S3066UF	2,008
	60 x 30 x 29½	1500 x 750 x 748	7___-S3060UF	1,934
	48 x 30 x 29½	1200 x 750 x 748	7___-S3048UF	1,829

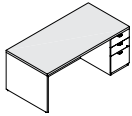

	W x D x H (in)	W x D x H (mm)	Code	Price (\$)
Left single pedestal bow front desks – low profile	<i>1 pedestal on left with lock, 2 box drawers and 1 file drawer with suspension bar. Pencil tray. Recessed, full-height modesty panel.</i>			
	84 x 42 x 29½	2100 x 1050 x 748	7___-UF4284SA	2,819
	72 x 42 x 29½	1800 x 1050 x 748	7___-UF4272SA	2,662

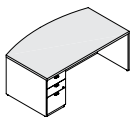

	W x D x H (in)	W x D x H (mm)	Code	Price (\$)
Right single pedestal bow front desks – low profile	<i>1 pedestal on right with lock, 2 box drawers and 1 file drawer with suspension bar. Pencil tray. Recessed, full-height modesty panel.</i>			
	84 x 42 x 29½	2100 x 1050 x 748	7___-S4284UFA	2,819
	72 x 42 x 29½	1800 x 1050 x 748	7___-S4272UFA	2,662

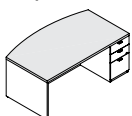

	W x D x H (in)	W x D x H (mm)	Code	Price (\$)
Desk shells	<i>Recessed, full-height modesty panel. Can accommodate 1 or 2 pedestals.</i>			
	72 x 36 x 29½	1800 x 900 x 748	7_NN-TDM3672	1,289
	72 x 30 x 29½	1800 x 750 x 748	7_NN-TDM3072	1,232
	66 x 30 x 29½	1650 x 750 x 748	7_NN-TDM3066	1,182
	60 x 30 x 29½	1500 x 750 x 748	7_NN-TDM3060	1,138

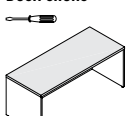

Specify the edge (N, 1, 2).

	W x D x H (in)	W x D x H (mm)	Code	Price (\$)
--	----------------	----------------	------	------------

Corner modules

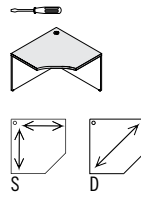

Full-height modesty panel. 1 grommet. Must be attached to a work surface.

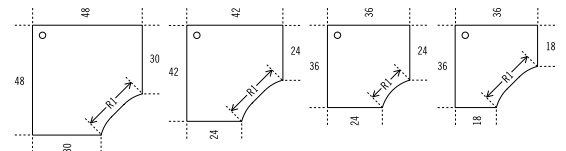

Surface	W x D x H (in)	W x D x H (mm)	Code	Price (\$)
48" x 30"	1200 x 750	7_NN-CM4830S	1,452	
42" x 24"	1050 x 600	7_NN-CM4224S	1,317	
36" x 24"	900 x 600	7_NN-CM3624S	1,127	
36" x 18"	900 x 450	7_NN-CM3618S	1,127	

Specify the edge (N, 1, 2).
Diagonal wood grain: change S to D, add 10% to the price.

Right extended corner modules – 24" D

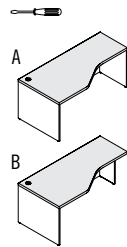

Full-height modesty panel. 1 grommet.

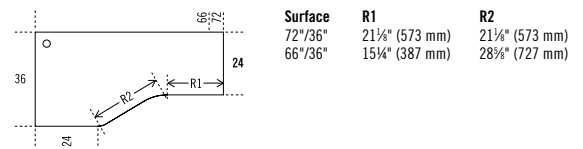

Surface	W x D x H (in)	W x D x H (mm)	Code	Price (\$)
72" x 36"	1800 x 900	7_NN-CM367224_	1,597	
66" x 36"	1650 x 900	7_NN-CM366624_	1,499	

Specify the edge (N, 1, 2). Specify panel legs (A, B).

Left extended corner modules – 24" D

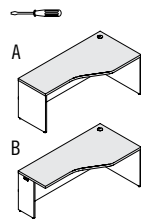

Full-height modesty panel. 1 grommet.

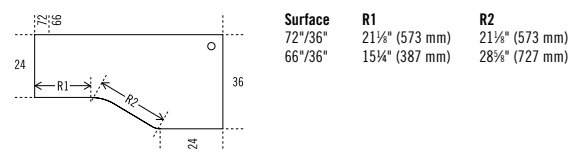

Surface	W x D x H (in)	W x D x H (mm)	Code	Price (\$)
72" x 36"	1800 x 900	7_NN-CM723624_	1,597	
66" x 36"	1650 x 900	7_NN-CM663624_	1,499	

Specify the edge (N, 1, 2). Specify panel legs (A, B).

Right extended corner modules – 20" D

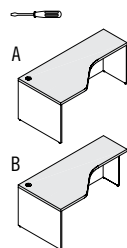

Full-height modesty panel. 1 grommet.

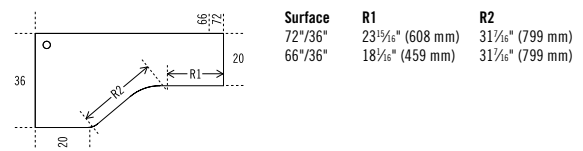

Surface	W x D x H (in)	W x D x H (mm)	Code	Price (\$)
72" x 36"	1800 x 900	7_NN-CM367220_	1,597	
66" x 36"	1650 x 900	7_NN-CM366620_	1,499	

Specify the edge (N, 1, 2). Specify panel legs (A, B).

Left extended corner modules – 20" D

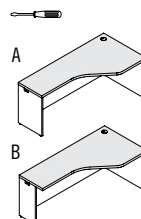

Full-height modesty panel. 1 grommet.

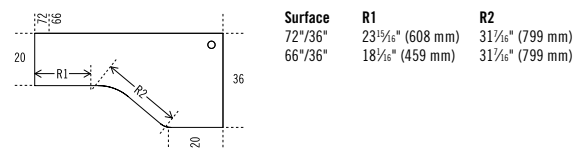

Surface	W x D x H (in)	W x D x H (mm)	Code	Price (\$)
72" x 36"	1800 x 900	7_NN-CM723620_	1,597	
66" x 36"	1650 x 900	7_NN-CM663620_	1,499	

Specify the edge (N, 1, 2). Specify panel legs (A, B).

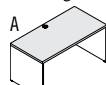
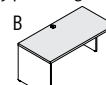
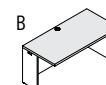
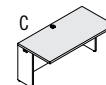
	W x D x H (in)	W x D x H (mm)	Code	Price (\$)
Rectangular tables – 30" D 	<i>Full-height modesty panel. 1 grommet.</i>			
				
	72 x 30 x 29½	1800 x 750 x 748	7_NN-DT3072_	1,201
	66 x 30 x 29½	1650 x 750 x 748	7_NN-DT3066_	1,161
	60 x 30 x 29½	1500 x 750 x 748	7_NN-DT3060_	1,119
	54 x 30 x 29½	1350 x 750 x 748	7_NN-DT3054_	1,071
	48 x 30 x 29½	1200 x 750 x 748	7_NN-DT3048_	998
	42 x 30 x 29½	1050 x 750 x 748	7_NN-DT3042_	942
	36 x 30 x 29½	900 x 750 x 748	7_NN-DT3036_	902
	30 x 30 x 29½	750 x 750 x 748	7_NN-DT3030_	862
24 x 30 x 29½	600 x 750 x 748	7_NN-DT3024_	823	

Specify the edge (N, 1, 2). Specify panel legs (A, B, C).

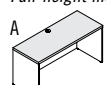
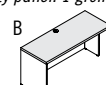
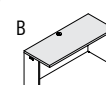
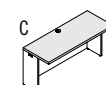
	W x D x H (in)	W x D x H (mm)	Code	Price (\$)
Rectangular tables – 24" D 	<i>Full-height modesty panel. 1 grommet.</i>			
				
	72 x 24 x 29½	1800 x 600 x 748	7_NN-DT2472_	1,166
	66 x 24 x 29½	1650 x 600 x 748	7_NN-DT2466_	1,119
	60 x 24 x 29½	1500 x 600 x 748	7_NN-DT2460_	1,076
	54 x 24 x 29½	1350 x 600 x 748	7_NN-DT2454_	1,028
	48 x 24 x 29½	1200 x 600 x 748	7_NN-DT2448_	965
	42 x 24 x 29½	1050 x 600 x 748	7_NN-DT2442_	911
	36 x 24 x 29½	900 x 600 x 748	7_NN-DT2436_	867
	30 x 24 x 29½	750 x 600 x 748	7_NN-DT2430_	807
24 x 24 x 29½	600 x 600 x 748	7_NN-DT2424_	777	

Specify the edge (N, 1, 2). Specify panel legs (A, B, C).

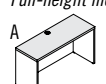
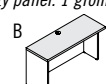
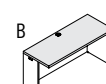
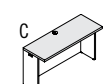
	W x D x H (in)	W x D x H (mm)	Code	Price (\$)
Rectangular tables – 20" D 	<i>Full-height modesty panel. 1 grommet.</i>			
				
	72 x 20 x 29½	1800 x 500 x 748	7_NN-DT2072_	1,127
	66 x 20 x 29½	1650 x 500 x 748	7_NN-DT2066_	1,080
	60 x 20 x 29½	1500 x 500 x 748	7_NN-DT2060_	1,033
	54 x 20 x 29½	1350 x 500 x 748	7_NN-DT2054_	984
	48 x 20 x 29½	1200 x 500 x 748	7_NN-DT2048_	926
	42 x 20 x 29½	1050 x 500 x 748	7_NN-DT2042_	877
	36 x 20 x 29½	900 x 500 x 748	7_NN-DT2036_	831
	30 x 20 x 29½	750 x 500 x 748	7_NN-DT2030_	779
24 x 20 x 29½	600 x 500 x 748	7_NN-DT2024_	731	

Specify the edge (N, 1, 2). Specify panel legs (A, B, C).

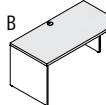
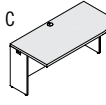
	W x D x H (in)	W x D x H (mm)	Code	Price (\$)
Asymmetrical tables – 30" D 	<i>To complete a standard corner module. Full-height modesty panel. 1 grommet.</i>			
				
	54 x 30 x 29½	1350 x 750 x 748	7_NN-AT305424_	1,114
	48 x 30 x 29½	1200 x 750 x 748	7_NN-AT304824_	1,033
	42 x 30 x 29½	1050 x 750 x 748	7_NN-AT304224_	998
	36 x 30 x 29½	900 x 750 x 748	7_NN-AT303624_	942
	30 x 30 x 29½	750 x 750 x 748	7_NN-AT303024_	902

Specify the edge (N, 1, 2). Specify panel legs (B, C).

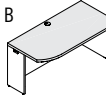
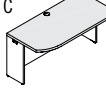
	W x D x H (in)	W x D x H (mm)	Code	Price (\$)
Asymmetrical tables – 30" D 	<i>To complete a standard corner module. Full-height modesty panel. 1 grommet.</i>			
				
	54 x 30 x 29½	1350 x 750 x 748	7_NN-AT245430_	1,114
	48 x 30 x 29½	1200 x 750 x 748	7_NN-AT244830_	1,033
	42 x 30 x 29½	1050 x 750 x 748	7_NN-AT244230_	998
	36 x 30 x 29½	900 x 750 x 748	7_NN-AT243630_	942
	30 x 30 x 29½	750 x 750 x 748	7_NN-AT243030_	902

Specify the edge (N, 1, 2). Specify panel legs (B, C).

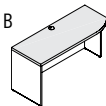
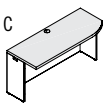
	W x D x H (in)	W x D x H (mm)	Code	Price (\$)
Asymmetrical tables – 24" D 	<i>To complete a standard corner module. Full-height modesty panel. 1 grommet.</i>			
				
	54 x 24 x 29½	1350 x 600 x 748	7_NN-AT245418_	1,065
	48 x 24 x 29½	1200 x 600 x 748	7_NN-AT244818_	998
	42 x 24 x 29½	1050 x 600 x 748	7_NN-AT244218_	942
	36 x 24 x 29½	900 x 600 x 748	7_NN-AT243618_	902
	30 x 24 x 29½	750 x 600 x 748	7_NN-AT243018_	862

Specify the edge (N, 1, 2). Specify panel legs (B, C).

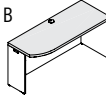
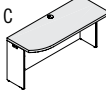
	W x D x H (in)	W x D x H (mm)	Code	Price (\$)
Asymmetrical tables – 24" D 	<i>To complete a standard corner module. Full-height modesty panel. 1 grommet.</i>			
				
	54 x 24 x 29½	1350 x 600 x 748	7_NN-AT185424_	1,065
	48 x 24 x 29½	1200 x 600 x 748	7_NN-AT184824_	998
	42 x 24 x 29½	1050 x 600 x 748	7_NN-AT184224_	942
	36 x 24 x 29½	900 x 600 x 748	7_NN-AT183624_	902
	30 x 24 x 29½	750 x 600 x 748	7_NN-AT183024_	862

Specify the edge (N, 1, 2). Specify panel legs (B, C).

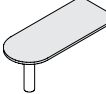
	W x D x H (in)	W x D x H (mm)	Code	Price (\$)
D-shaped surfaces 	<i>Steel leg: A Anthracite Grey. Must be attached to a work surface.</i>			
				
	72 x 36 x 29½	1800 x 900 x 748	7_NA-BU3672	1,193
	72 x 30 x 29½	1800 x 750 x 748	7_NA-BU3072	1,102
	66 x 30 x 29½	1650 x 750 x 748	7_NA-BU3066	1,047
	60 x 30 x 29½	1500 x 750 x 748	7_NA-BU3060	998
	66 x 24 x 29½	1650 x 600 x 748	7_NA-BU2466	951
	60 x 24 x 29½	1500 x 600 x 748	7_NA-BU2460	885
48 x 24 x 29½	1200 x 600 x 748	7_NA-BU2448	839	

Packaged in 2 boxes.

Steel leg options, change A to:
B Brass, add \$323;
N Nickel, add \$323.

Specify the edge (N, 1, 2).

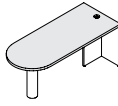
	W x D x H (in)	W x D x H (mm)	Code	Price (\$)
D-shaped work tables	<i>Steel leg: A Anthracite Grey. 1 grommet. Must be attached to a work surface.</i>			
	72 x 36 x 29½	1800 x 900 x 748	7_NA-BT3672	1,371
	72 x 30 x 29½	1800 x 750 x 748	7_NA-BT3072	1,317
	66 x 30 x 29½	1650 x 750 x 748	7_NA-BT3066	1,264
	60 x 30 x 29½	1500 x 750 x 748	7_NA-BT3060	1,201
Packaged in 2 boxes.	66 x 24 x 29½	1650 x 600 x 748	7_NA-BT2466	1,169
Steel leg options, change A to:	60 x 24 x 29½	1500 x 600 x 748	7_NA-BT2460	1,119
B Brass, add \$323;	48 x 24 x 29½	1200 x 600 x 748	7_NA-BT2448	1,071
N Nickel, add \$323.	Specify the edge (N, 1, 2).			

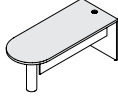
	W x D x H (in)	W x D x H (mm)	Code	Price (\$)
D-shaped work tables	<i>Reversible modesty panel. Steel leg: A Anthracite Grey. 1 grommet. Must be attached to a work surface.</i>			
	72 x 36 x 29½	1800 x 900 x 748	7_NA-BTM3672	1,499
	72 x 30 x 29½	1800 x 750 x 748	7_NA-BTM3072	1,434
	66 x 30 x 29½	1650 x 750 x 748	7_NA-BTM3066	1,379
Packaged in 2 boxes.	60 x 30 x 29½	1500 x 750 x 748	7_NA-BTM3060	1,335
Steel leg options, change A to:	Specify the edge (N, 1, 2).			
B Brass, add \$323;				
N Nickel, add \$323.				

	W x D x H (in)	W x D x H (mm)	Code	Price (\$)
Left P-shaped work tables	<i>Steel leg: A Anthracite Grey. 1 grommet. Must be attached to a work surface.</i>			
	72 x 42 x 29½	1800 x 1050 x 748	7_NA-PT3072	1,506
	66 x 42 x 29½	1650 x 1050 x 748	7_NA-PT3066	1,475
	60 x 42 x 29½	1500 x 1050 x 748	7_NA-PT3060	1,445
Packaged in 2 boxes.	Specify the edge (N, 1, 2).			

Steel leg options, change A to:
B Brass, add \$323;
N Nickel, add \$323.

	W x D x H (in)	W x D x H (mm)	Code	Price (\$)
Right P-shaped work tables	<i>Steel leg: A Anthracite Grey. 1 grommet. Must be attached to a work surface.</i>			
	72 x 42 x 29½	1800 x 1050 x 748	7_NA-3072PT	1,506
	66 x 42 x 29½	1650 x 1050 x 748	7_NA-3066PT	1,475
	60 x 42 x 29½	1500 x 1050 x 748	7_NA-3060PT	1,445
Packaged in 2 boxes.	Specify the edge (N, 1, 2).			

Steel leg options, change A to:
B Brass, add \$323;
N Nickel, add \$323.

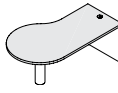
	W x D x H (in)	W x D x H (mm)	Code	Price (\$)
Left P-shaped work tables	<i>Modesty panel. Steel leg: A Anthracite Grey. 1 grommet. Must be attached to a work surface.</i>			
	72 x 42 x 29½	1800 x 1050 x 748	7_NA-PTM3072	1,605
	66 x 42 x 29½	1650 x 1050 x 748	7_NA-PTM3066	1,572
	60 x 42 x 29½	1500 x 1050 x 748	7_NA-PTM3060	1,530
Packaged in 2 boxes.	Specify the edge (N, 1, 2).			

Steel leg options, change A to:
B Brass, add \$323;
N Nickel, add \$323.

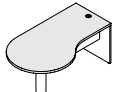
	W x D x H (in)	W x D x H (mm)	Code	Price (\$)
Right P-shaped work tables	<i>Modesty panel. Steel leg: A Anthracite Grey. 1 grommet. Must be attached to a work surface.</i>			
	72 x 42 x 29½	1800 x 1050 x 748	7_NA-3072PTM	1,605
	66 x 42 x 29½	1650 x 1050 x 748	7_NA-3066PTM	1,572
	60 x 42 x 29½	1500 x 1050 x 748	7_NA-3060PTM	1,530
Packaged in 2 boxes.	Specify the edge (N, 1, 2).			

Steel leg options, change A to:
B Brass, add \$323;
N Nickel, add \$323.

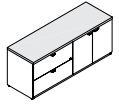
	W x D x H (in)	W x D x H (mm)	Code	Price (\$)
Lateral file / bookcase credenzas	<i>2 file drawers with suspension bars. Bookcase unit with doors and adjustable shelf. Locks.</i>			
	72 x 24 x 29½	1800 x 600 x 748	7___-LF2472B	2,577
	72 x 20 x 29½	1800 x 500 x 748	7___-LF2072B	2,401
Specify the edge (N, 1, 2). Specify the handle code (D, K). Specify the accent color (A, B, N).				

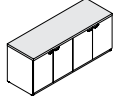
	W x D x H (in)	W x D x H (mm)	Code	Price (\$)
Bookcase credenzas	<i>Storage unit with doors and adjustable shelves. Locks.</i>			
	72 x 24 x 29½	1800 x 600 x 748	7___-B2472B	2,344
	72 x 20 x 29½	1800 x 500 x 748	7___-B2072B	2,175
Specify the edge (N, 1, 2). Specify the handle code (D, K). Specify the accent color (A, B, N).				

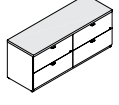
	W x D x H (in)	W x D x H (mm)	Code	Price (\$)
Lateral file credenzas	<i>4 file drawers with suspension bars. Locks. Optional counterweights to meet BIFMA standards, refer to page 108.</i>			
	72 x 24 x 29½	1800 x 600 x 748	7___-LF2472LF	2,829
	72 x 20 x 29½	1800 x 500 x 748	7___-LF2072LF	2,668
Specify the edge (N, 1, 2). Specify the handle code (D, K). Specify the accent color (A, B, N).				

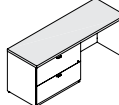
	W x D x H (in)	W x D x H (mm)	Code	Price (\$)
Left lateral file credenzas	<i>2 file drawers on left with suspension bars. Lock. Grommet on back.</i>			
	72 x 24 x 29½	1800 x 600 x 748	7___-LF2472S	2,231
	66 x 24 x 29½	1650 x 600 x 748	7___-LF2466S	2,150
	60 x 24 x 29½	1500 x 600 x 748	7___-LF2460S	2,057
	72 x 20 x 29½	1800 x 500 x 748	7___-LF2072S	2,057
	66 x 20 x 29½	1650 x 500 x 748	7___-LF2066S	1,983
	60 x 20 x 29½	1500 x 500 x 748	7___-LF2060S	1,926
Specify the edge (N, 1, 2). Specify the handle code (D, K). Specify the accent color (A, B, N).				

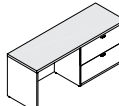
	W x D x H (in)	W x D x H (mm)	Code	Price (\$)
Right lateral file credenzas	<i>2 file drawers on right with suspension bars. Lock. Grommet on back.</i>			
	72 x 24 x 29½	1800 x 600 x 748	7___-S2472LF	2,231
	66 x 24 x 29½	1650 x 600 x 748	7___-S2466LF	2,150
	60 x 24 x 29½	1500 x 600 x 748	7___-S2460LF	2,057
	72 x 20 x 29½	1800 x 500 x 748	7___-S2072LF	2,057
	66 x 20 x 29½	1650 x 500 x 748	7___-S2066LF	1,983
	60 x 20 x 29½	1500 x 500 x 748	7___-S2060LF	1,926
Specify the edge (N, 1, 2). Specify the handle code (D, K). Specify the accent color (A, B, N).				

	W x D x H (in)	W x D x H (mm)	Code	Price (\$)
Left open bookcase credenzas	<i>1 adjustable shelf. Full-height modesty panel. Grommet on back.</i>			
	72 x 24 x 29½	1800 x 600 x 748	7_NN-BE2472S	1,766
	72 x 20 x 29½	1800 x 500 x 748	7_NN-BE2072S	1,669
Specify the edge (N, 1, 2).				

	W x D x H (in)	W x D x H (mm)	Code	Price (\$)
Right open bookcase credenzas	<i>1 adjustable shelf. Full-height modesty panel. Grommet on back.</i>			
	72 x 24 x 29½	1800 x 600 x 748	7_NN-S2472BE	1,766
	72 x 20 x 29½	1800 x 500 x 748	7_NN-S2072BE	1,669
Specify the edge (N, 1, 2).				

	W x D x H (in)	W x D x H (mm)	Code	Price (\$)
Open bookcase credenzas	<i>1 adjustable shelf on each side.</i>			
	72 x 24 x 29½	1800 x 600 x 748	7_NN-BE2472BE	1,918
	72 x 20 x 29½	1800 x 500 x 748	7_NN-BE2072BE	1,829
Specify the edge (N, 1, 2).				

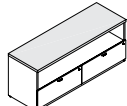
	W x D x H (in)	W x D x H (mm)	Code	Price (\$)
Lateral file credenzas 	<i>Open space on top and 2 lateral file drawers on bottom with suspension bars. Locks. Grommet on back. Optional counterweights to meet BIFMA standards, refer to page 108.</i>			
	72 x 24 x 29½	1800 x 600 x 748	7___-SLF2472	2,217
	72 x 20 x 29½	1800 x 500 x 748	7___-SLF2072	2,135
Specify the edge (N, 1, 2). Specify the handle code (D, K). Specify the accent color (A, B, N).				

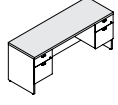
	W x D x H (in)	W x D x H (mm)	Code	Price (\$)
Double pedestal credenzas 	<i>2 pedestals with locks, 2 box drawers and 2 file drawers with suspension bars. Pencil tray. Grommet on back.</i>			
	72 x 24 x 29½	1800 x 600 x 748	7___-F2472KF	2,106
	66 x 24 x 29½	1650 x 600 x 748	7___-F2466KF	2,087
	60 x 24 x 29½	1500 x 600 x 748	7___-F2460KF	2,057
	72 x 20 x 29½	1800 x 500 x 748	7___-F2072KF	1,950
	66 x 20 x 29½	1650 x 500 x 748	7___-F2066KF	1,918
	60 x 20 x 29½	1500 x 500 x 748	7___-F2060KF	1,882
Specify the edge (N, 1, 2). Specify the handle code (D, K). Specify the accent color (A, B, N).				

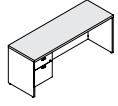
	W x D x H (in)	W x D x H (mm)	Code	Price (\$)
Left single pedestal credenzas 	<i>1 pedestal on left with lock, 1 box drawer and 1 file drawer with suspension bar. Pencil tray. Grommet on back.</i>			
	72 x 24 x 29½	1800 x 600 x 748	7___-F2472S	1,676
	66 x 24 x 29½	1650 x 600 x 748	7___-F2466S	1,640
	60 x 24 x 29½	1500 x 600 x 748	7___-F2460S	1,612
	72 x 20 x 29½	1800 x 500 x 748	7___-F2072S	1,640
	66 x 20 x 29½	1650 x 500 x 748	7___-F2066S	1,612
	60 x 20 x 29½	1500 x 500 x 748	7___-F2060S	1,578
Specify the edge (N, 1, 2). Specify the handle code (D, K). Specify the accent color (A, B, N).				

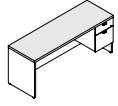
	W x D x H (in)	W x D x H (mm)	Code	Price (\$)
Right single pedestal credenzas 	<i>1 pedestal on right with lock, 1 box drawer and 1 file drawer with suspension bar. Pencil tray. Grommet on back.</i>			
	72 x 24 x 29½	1800 x 600 x 748	7___-S2472F	1,676
	66 x 24 x 29½	1650 x 600 x 748	7___-S2466F	1,640
	60 x 24 x 29½	1500 x 600 x 748	7___-S2460F	1,612
	72 x 20 x 29½	1800 x 500 x 748	7___-S2072F	1,640
	66 x 20 x 29½	1650 x 500 x 748	7___-S2066F	1,612
	60 x 20 x 29½	1500 x 500 x 748	7___-S2060F	1,578
Specify the edge (N, 1, 2). Specify the handle code (D, K). Specify the accent color (A, B, N).				

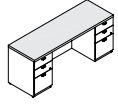
	W x D x H (in)	W x D x H (mm)	Code	Price (\$)
Double pedestal credenzas – low profile 	<i>2 pedestals with locks, 4 box drawers and 2 file drawers with suspension bars. Pencil tray. Grommet on back.</i>			
	72 x 24 x 29½	1800 x 600 x 748	7___-UF2472UF	2,620
	66 x 24 x 29½	1650 x 600 x 748	7___-UF2466UF	2,604
	60 x 24 x 29½	1500 x 600 x 748	7___-UF2460UF	2,571
	72 x 20 x 29½	1800 x 500 x 748	7___-UF2072UF	2,466
	66 x 20 x 29½	1650 x 500 x 748	7___-UF2066UF	2,433
	60 x 20 x 29½	1500 x 500 x 748	7___-UF2060UF	2,401
Specify the edge (N, 1, 2). Specify the handle code (D, K). Specify the accent color (A, B, N).				

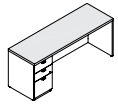
	W x D x H (in)	W x D x H (mm)	Code	Price (\$)
Left single pedestal credenzas – low profile 	<i>1 pedestal on left with lock, 2 box drawers and 1 file drawer with suspension bar. Pencil tray. Grommet on back.</i>			
	72 x 24 x 29½	1800 x 600 x 748	7___-UF2472S	1,934
	66 x 24 x 29½	1650 x 600 x 748	7___-UF2466S	1,904
	60 x 24 x 29½	1500 x 600 x 748	7___-UF2460S	1,869
	72 x 20 x 29½	1800 x 500 x 748	7___-UF2072S	1,904
	66 x 20 x 29½	1650 x 500 x 748	7___-UF2066S	1,869
	60 x 20 x 29½	1500 x 500 x 748	7___-UF2060S	1,829
Specify the edge (N, 1, 2). Specify the handle code (D, K). Specify the accent color (A, B, N).				

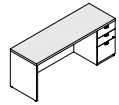
	W x D x H (in)	W x D x H (mm)	Code	Price (\$)
Right single pedestal credenzas – low profile 	<i>1 pedestal on right with lock, 2 box drawers and 1 file drawer with suspension bar. Pencil tray. Grommet on back.</i>			
	72 x 24 x 29½	1800 x 600 x 748	7___-S2472UF	1,934
	66 x 24 x 29½	1650 x 600 x 748	7___-S2466UF	1,904
	60 x 24 x 29½	1500 x 600 x 748	7___-S2460UF	1,869
	72 x 20 x 29½	1800 x 500 x 748	7___-S2072UF	1,904
	66 x 20 x 29½	1650 x 500 x 748	7___-S2066UF	1,869
	60 x 20 x 29½	1500 x 500 x 748	7___-S2060UF	1,829
Specify the edge (N, 1, 2). Specify the handle code (D, K). Specify the accent color (A, B, N).				

	W x D x H (in)	W x D x H (mm)	Code	Price (\$)
Return shells 	<i>Reversible. Grommet. Can accommodate 1 pedestal.</i>			
	48 x 24 x 29½	1200 x 600 x 748	7_NN-R2448S	752
	42 x 24 x 29½	1050 x 600 x 748	7_NN-R2442S	701
	48 x 20 x 29½	1200 x 500 x 748	7_NN-R2448S	677
	42 x 20 x 29½	1050 x 500 x 748	7_NN-R2042S	629
Specify the edge (N, 1, 2).				

	W x D x H (in)	W x D x H (mm)	Code	Price (\$)
Left executive returns 	<i>1 pedestal on left with lock, 1 box drawer and 1 file drawer with suspension bar. Pencil tray. Grommet.</i>			
	48 x 24 x 29½	1200 x 600 x 748	7___-F2448R	1,345
	42 x 24 x 29½	1050 x 600 x 748	7___-F2442R	1,282
	48 x 20 x 29½	1200 x 500 x 748	7___-F2048R	1,289
	42 x 20 x 29½	1050 x 500 x 748	7___-F2042R	1,256
Specify the edge (N, 1, 2). Specify the handle code (D, K). Specify the accent color (A, B, N).				

	W x D x H (in)	W x D x H (mm)	Code	Price (\$)
Right executive returns 	<i>1 pedestal on right with lock, 1 box drawer and 1 file drawer with suspension bar. Pencil tray. Grommet.</i>			
	48 x 24 x 29½	1200 x 600 x 748	7___-R2448F	1,345
	42 x 24 x 29½	1050 x 600 x 748	7___-R2442F	1,282
	48 x 20 x 29½	1200 x 500 x 748	7___-R2048F	1,289
	42 x 20 x 29½	1050 x 500 x 748	7___-R2042F	1,256
Specify the edge (N, 1, 2). Specify the handle code (D, K). Specify the accent color (A, B, N).				

	W x D x H (in)	W x D x H (mm)	Code	Price (\$)
Left executive returns – low profile 	<i>1 pedestal on left with lock, 2 box drawers and 1 file drawer with suspension bar. Pencil tray. Grommet.</i>			
	48 x 24 x 29½	1200 x 600 x 748	7___-UF2448R	1,605
	42 x 24 x 29½	1050 x 600 x 748	7___-UF2442R	1,530
	48 x 20 x 29½	1200 x 500 x 748	7___-UF2048R	1,546
	42 x 20 x 29½	1050 x 500 x 748	7___-UF2042R	1,499
Specify the edge (N, 1, 2). Specify the handle code (D, K). Specify the accent color (A, B, N).				

	W x D x H (in)	W x D x H (mm)	Code	Price (\$)
Right executive returns – low profile 	<i>1 pedestal on right with lock, 2 box drawers and 1 file drawer with suspension bar. Pencil tray. Grommet.</i>			
	48 x 24 x 29½	1200 x 600 x 748	7___-R2448UF	1,605
	42 x 24 x 29½	1050 x 600 x 748	7___-R2442UF	1,530
	48 x 20 x 29½	1200 x 500 x 748	7___-R2048UF	1,546
	42 x 20 x 29½	1050 x 500 x 748	7___-R2042UF	1,499
Specify the edge (N, 1, 2). Specify the handle code (D, K). Specify the accent color (A, B, N).				

	W x D x H (in)	W x D x H (mm)	Code	Price (\$)
Bridge-returns 	<i>Full-height modesty panel. 1 grommet.</i>			
	48 x 24 x 29½	1200 x 600 x 748	7_NN-BR2448	620
	42 x 24 x 29½	1050 x 600 x 748	7_NN-BR2442	580
	36 x 24 x 29½	900 x 600 x 748	7_NN-BR2436	549
	48 x 20 x 29½	1200 x 500 x 748	7_NN-BR2048	563
	42 x 20 x 29½	1050 x 500 x 748	7_NN-BR2042	525
	36 x 20 x 29½	900 x 500 x 748	7_NN-BR2036	490
Specify the edge (N, 1, 2).				

Hutches with doors – 44" H

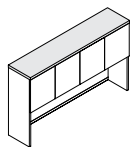

84" to 60": 4 doors
54" to 48": 3 doors
42" to 36": 2 doors

W x D x H (in)	W x D x H (mm)	Code	Price (\$)
<i>Clearance: 21¼". Grommet. Full-width wire access. Can accommodate a tackboard, refer to page 107.</i>			
84 x 16 x 44	2100 x 400 x 1099	7_NN-E844416P	2,106
78 x 16 x 44	1950 x 400 x 1099	7_NN-E784416P	2,029
72 x 16 x 44	1800 x 400 x 1099	7_NN-E724416P	1,950
66 x 16 x 44	1650 x 400 x 1099	7_NN-E664416P	1,877
60 x 16 x 44	1500 x 400 x 1099	7_NN-E604416P	1,786
54 x 16 x 44	1350 x 400 x 1099	7_NN-E544416P	1,716
48 x 16 x 44	1200 x 400 x 1099	7_NN-E484416P	1,605
42 x 16 x 44	1050 x 400 x 1099	7_NN-E424416P	1,490
36 x 16 x 44	900 x 400 x 1099	7_NN-E364416P	1,384

Specify the edge (N, 1, 2).

Hutches with doors – 36" H

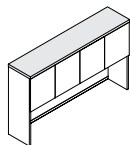

84" to 60": 4 doors
54" to 48": 3 doors
42" to 36": 2 doors

W x D x H (in)	W x D x H (mm)	Code	Price (\$)
<i>Clearance: 17¾". Grommet. Full-width wire access. Can accommodate a tackboard, refer to page 107.</i>			
84 x 16 x 36	2100 x 400 x 900	7_NN-E843616P	1,934
78 x 16 x 36	1950 x 400 x 900	7_NN-E783616P	1,869
72 x 16 x 36	1800 x 400 x 900	7_NN-E723616P	1,780
66 x 16 x 36	1650 x 400 x 900	7_NN-E663616P	1,709
60 x 16 x 36	1500 x 400 x 900	7_NN-E603616P	1,628
54 x 16 x 36	1350 x 400 x 900	7_NN-E543616P	1,557
48 x 16 x 36	1200 x 400 x 900	7_NN-E483616P	1,434
42 x 16 x 36	1050 x 400 x 900	7_NN-E423616P	1,329
36 x 16 x 36	900 x 400 x 900	7_NN-E363616P	1,219

Specify the edge (N, 1, 2).

Open hutches – 44" H

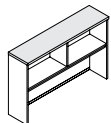

W x D x H (in)	W x D x H (mm)	Code	Price (\$)
<i>Clearance: 21¼". Grommet. Full-width wire access. Can accommodate a tackboard, refer to page 107.</i>			
84 x 16 x 44	2100 x 400 x 1099	7_NN-E844416	1,766
78 x 16 x 44	1950 x 400 x 1099	7_NN-E784416	1,702
72 x 16 x 44	1800 x 400 x 1099	7_NN-E724416	1,621
66 x 16 x 44	1650 x 400 x 1099	7_NN-E664416	1,546
60 x 16 x 44	1500 x 400 x 1099	7_NN-E604416	1,459
54 x 16 x 44	1350 x 400 x 1099	7_NN-E544416	1,384
48 x 16 x 44	1200 x 400 x 1099	7_NN-E484416	1,274
42 x 16 x 44	1050 x 400 x 1099	7_NN-E424416	1,161
36 x 16 x 44	900 x 400 x 1099	7_NN-E364416	1,054

Specify the edge (N, 1, 2).

Open hutches – 36" H

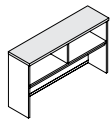

W x D x H (in)	W x D x H (mm)	Code	Price (\$)
<i>Clearance: 17¾". Grommet. Full-width wire access. Can accommodate a tackboard, refer to page 107.</i>			
84 x 16 x 36	2100 x 400 x 900	7_NN-E843616	1,605
78 x 16 x 36	1950 x 400 x 900	7_NN-E783616	1,538
72 x 16 x 36	1800 x 400 x 900	7_NN-E723616	1,452
66 x 16 x 36	1650 x 400 x 900	7_NN-E663616	1,379
60 x 16 x 36	1500 x 400 x 900	7_NN-E603616	1,298
54 x 16 x 36	1350 x 400 x 900	7_NN-E543616	1,219
48 x 16 x 36	1200 x 400 x 900	7_NN-E483616	1,102
42 x 16 x 36	1050 x 400 x 900	7_NN-E423616	998
36 x 16 x 36	900 x 400 x 900	7_NN-E363616	885

Specify the edge (N, 1, 2).

Wall-mounted hutches with doors – 22" H

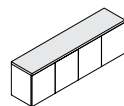

84" to 60": 4 doors
54" to 48": 3 doors
42" to 36": 2 doors

W x D x H (in)	W x D x H (mm)	Code	Price (\$)
<i>Hanger bar included for wall-mount installation. Can accommodate a tackboard, refer to page 107.</i>			
84 x 16 x 22	2100 x 400 x 550	7_NN-EM842216P	1,974
78 x 16 x 22	1950 x 400 x 550	7_NN-EM782216P	1,910
72 x 16 x 22	1800 x 400 x 550	7_NN-EM722216P	1,829
66 x 16 x 22	1650 x 400 x 550	7_NN-EM662216P	1,749
60 x 16 x 22	1500 x 400 x 550	7_NN-EM602216P	1,669
54 x 16 x 22	1350 x 400 x 550	7_NN-EM542216P	1,597
48 x 16 x 22	1200 x 400 x 550	7_NN-EM482216P	1,475
42 x 16 x 22	1050 x 400 x 550	7_NN-EM422216P	1,371
36 x 16 x 22	900 x 400 x 550	7_NN-EM362216P	1,264

Specify the edge (N, 1, 2).

Wall-mounted open hutches – 22" H

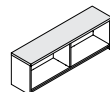

W x D x H (in)	W x D x H (mm)	Code	Price (\$)
<i>Hanger bar included for wall-mount installation. Can accommodate a tackboard, refer to page 107.</i>			
84 x 16 x 22	2100 x 400 x 550	7_NN-EM842216	1,640
78 x 16 x 22	1950 x 400 x 550	7_NN-EM782216	1,578
72 x 16 x 22	1800 x 400 x 550	7_NN-EM722216	1,490
66 x 16 x 22	1650 x 400 x 550	7_NN-EM662216	1,419
60 x 16 x 22	1500 x 400 x 550	7_NN-EM602216	1,335
54 x 16 x 22	1350 x 400 x 550	7_NN-EM542216	1,264
48 x 16 x 22	1200 x 400 x 550	7_NN-EM482216	1,144
42 x 16 x 22	1050 x 400 x 550	7_NN-EM422216	1,041
36 x 16 x 22	900 x 400 x 550	7_NN-EM362216	926

Specify the edge (N, 1, 2).

Lateral file units



W x D x H (in)	W x D x H (mm)	Code	Price (\$)
<i>Suspension bars. Lock. Optional counterweights to meet BIFMA standards, refer to page 108.</i>			
36 x 24 x 29½	900 x 600 x 748	7_--_-2436LF	1,506
30 x 24 x 29½	750 x 600 x 748	7_--_-2430LF	1,452
36 x 20 x 29½	900 x 500 x 748	7_--_-2036LF	1,467
30 x 20 x 29½	750 x 500 x 748	7_--_-2030LF	1,402

Specify the edge (N, 1, 2). Specify the handle code (D, K). Specify the accent color (A, B, N).

Bookcase units with doors



W x D x H (in)	W x D x H (mm)	Code	Price (\$)
<i>Adjustable shelf. Lock.</i>			
36 x 24 x 29½	900 x 600 x 748	7_--_-2436B	1,329
30 x 24 x 29½	750 x 600 x 748	7_--_-2430B	1,264
36 x 20 x 29½	900 x 500 x 748	7_--_-2036B	1,282
30 x 20 x 29½	750 x 500 x 748	7_--_-2030B	1,201

Specify the edge (N, 1, 2). Specify the handle code (D, K). Specify the accent color (A, B, N).

Combined pedestals



W x D x H (in)	W x D x H (mm)	Code	Price (\$)
<i>2 box drawers, 2 file drawers with suspension bars. Lock. Pencil tray.</i>			
36 x 24 x 29½	900 x 600 x 748	7_--_-2436C0	1,910
36 x 20 x 29½	900 x 500 x 748	7_--_-2036C0	1,854

Specify the edge (N, 1, 2). Specify the handle code (D, K). Specify the accent color (A, B, N).

Combined pedestals



W x D x H (in)	W x D x H (mm)	Code	Price (\$)
<i>2 box drawers, 2 file drawers with suspension bars. Lock. Pencil tray.</i>			
36 x 24 x 29½	900 x 600 x 748	7_--_-C02436	1,910
36 x 20 x 29½	900 x 500 x 748	7_--_-C02036	1,854

Specify the edge (N, 1, 2). Specify the handle code (D, K). Specify the accent color (A, B, N).

Modular lateral files



W x D x H (in)	W x D x H (mm)	Code	Price (\$)
<i>2 file drawers with suspension bars. Lock. Goes under a work surface. 1 tone only.</i>			
36 x 18 x 28	900 x 448 x 711	7N_--_-1836LFL	1,289
30 x 18 x 28	750 x 448 x 711	7N_--_-1830LFL	1,219

Specify the handle code (D, K). Specify the accent color (A, B, N).

	W x D x H (in)	W x D x H (mm)	Code	Price (\$)
Modular combined pedestal 	<i>2 box drawers on left, 2 file drawers with suspension bars. Lock. Pencil tray. Goes under a work surface. 1 tone only.</i>			
	36 x 18 x 28	900 x 448 x 711	7N__-1836COL	1,654
Specify the handle code (D, K). Specify the accent color (A, B, N).				

Modular combined pedestal 	<i>2 box drawers on right, 2 file drawers with suspension bars. Lock. Pencil tray. Goes under a work surface. 1 tone only.</i>			
	36 x 18 x 28	900 x 448 x 711	7N__-C01836L	1,654
Specify the handle code (D, K). Specify the accent color (A, B, N).				

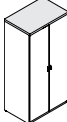

Modular bookcases with doors 	<i>1 adjustable shelf. Lock. Goes under a work surface. 1 tone only.</i>			
	36 x 18 x 28	900 x 448 x 711	7N__-1836BL	1,161
	30 x 18 x 28	750 x 448 x 711	7N__-1830BL	1,096
Specify the handle code (D, K). Specify the accent color (A, B, N).				

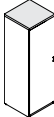

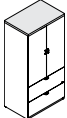
Storage or wardrobe units 	<i>3 adjustable shelves. 1 full-width fixed shelf. Full-width clothes hanger bar. 73" H storage unit matches the height of a credenza with a 44" H hutch. 65" H storage unit matches the height of a credenza with a 36" H hutch.</i>			
	36 x 24 x 73½	900 x 600 x 1847	7___-243673B	2,371
	36 x 20 x 73½	900 x 500 x 1847	7___-203673B	2,191
	36 x 24 x 65½	900 x 600 x 1648	7___-243665B	2,241
	36 x 20 x 65½	900 x 500 x 1648	7___-203665B	2,062
Specify the edge (N, 1, 2). Specify the handle code (D, K). Specify the accent color (A, B, N).				

Storage or wardrobe units 	<i>Reversible door. 3 adjustable shelves. 1 full-width fixed shelf. Full-width clothes hanger bar. 73" H storage unit matches the height of a credenza with a 44" H hutch. 65" H storage unit matches the height of a credenza with a 36" H hutch.</i>			
	24 x 24 x 73½	600 x 600 x 1847	7___-242473B	1,806
	24 x 20 x 73½	600 x 500 x 1847	7___-202473B	1,716
	24 x 24 x 65½	600 x 600 x 1648	7___-242465B	1,716
	24 x 20 x 65½	600 x 500 x 1648	7___-202465B	1,635
Specify the edge (N, 1, 2). Specify the handle code (D, K). Specify the accent color (A, B, N).				

Storage units with lateral file 	<i>2 adjustable shelves. 2 lateral file drawers with suspension bars. Lock on drawer. 73" H storage matches the height of a credenza with a 44" H hutch. 65" H storage unit matches the height of a credenza with a 36" H hutch.</i>			
	36 x 24 x 73½	900 x 600 x 1847	7___-243673LFB	2,878
	36 x 20 x 73½	900 x 500 x 1847	7___-203673LFB	2,706
	36 x 24 x 65½	900 x 600 x 1648	7___-243665LFB	2,774
	36 x 20 x 65½	900 x 500 x 1648	7___-203665LFB	2,604
Specify the edge (N, 1, 2). Specify the handle code (D, K). Specify the accent color (A, B, N).				

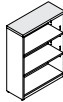

Storage units with lateral file 	<i>Reversible door. 2 adjustable shelves. 2 lateral file drawers with suspension bars. Lock. 73" H storage unit matches the height of a credenza with a 44" H hutch. 65" H storage unit matches the height of a credenza with a 36" H hutch.</i>			
	24 x 24 x 73½	600 x 600 x 1847	7___-242473FB	2,401
	24 x 20 x 73½	600 x 500 x 1847	7___-202473FB	2,231
	24 x 24 x 65½	600 x 600 x 1648	7___-242465FB	2,305
	24 x 20 x 65½	600 x 500 x 1648	7___-202465FB	2,135
Specify the edge (N, 1, 2). Specify the handle code (D, K). Specify the accent color (A, B, N).				

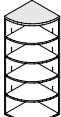

	W x D x H (in)	W x D x H (mm)	Code		Price (\$)
Open bookcases 	<i>4 adjustable shelves.</i>				
	36 x 14 x 73½	900 x 350 x 1847	7_NN-B367314		1,335
	36 x 14 x 65½	900 x 350 x 1648	7_NN-B366514		1,256
Specify the edge (N, 1, 2).					

	<i>2 adjustable shelves.</i>				
	36 x 14 x 48½	900 x 350 x 1226	7_NN-B364814		1,119
	Specify the edge (N, 1, 2).				
<i>Additional shelf.</i>					
34 x 13 x 1	846 x 325 x 25	7NNN-TB3614.1E		168	

Corner open bookcases 	<i>4 adjustable shelves.</i>				
	24 x 24 x 73½	600 x 600 x 1847	7_NN-B242473		1,459
	20 x 20 x 73½	500 x 500 x 1847	7_NN-B202073		1,371
	24 x 24 x 65½	600 x 600 x 1648	7_NN-B242465		1,371
	20 x 20 x 65½	500 x 500 x 1648	7_NN-B202065		1,298
Specify the edge (N, 1, 2).					

Corner open bookcases 	<i>1 adjustable shelf.</i>				
	24 x 24 x 29½	600 x 600 x 748	7_NN-B242429		942
	20 x 20 x 29½	500 x 500 x 748	7_NN-B202029		862
Specify the edge (N, 1, 2).					



Mobile pedestals 	<i>2 box drawers, 1 file drawer with suspension bar. Pencil tray. Brakes on front casters. Lock. Fits under a work surface. 1 tone only.</i>				
	15 x 23 x 27½	390 x 575 x 689	7N__-MP1523UF		1,219
	15 x 18 x 27½	390 x 450 x 689	7N__-MP1518UF		1,138
Specify the handle code (D, K). Specify the accent color (A, B, N).					





Mobile pedestal 	<i>2 file drawers with suspension bars. Brakes on front casters. Lock. Fits under a work surface. 1 tone only.</i>				
	15 x 23 x 27½	390 x 575 x 689	7N__-MP1523FF		1,161
Specify the handle code (D, K). Specify the accent color (A, B, N).					





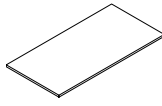
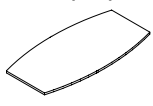

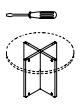
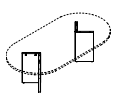

Mobile pedestals 	<i>1 box drawer and 1 file drawer with suspension bar. Pencil tray. Brakes on front casters. Lock. Fits under a work surface. 1 tone only.</i>				
	15 x 23 x 21¼	390 x 575 x 521	7N__-MP1523F		1,119
	15 x 18 x 21¼	390 x 450 x 521	7N__-MP1518F		1,080
Specify the handle code (D, K). Specify the accent color (A, B, N).					

Modular pedestal 	<i>2 box drawers, 1 file drawer with suspension bar. Pencil tray. Lock. Must be installed under a work surface. 1 tone only.</i>				
	15 x 18 x 28	388 x 448 x 713	7N__-P1518UFL		1,054
Specify the handle code (D, K). Specify the accent color (A, B, N).					

Modular pedestal 	<i>2 file drawers with suspension bars. Lock. Must be installed under a work surface. 1 tone only.</i>				
	15 x 18 x 28	388 x 448 x 713	7N__-P1518FFL		1,015
Specify the handle code (D, K). Specify the accent color (A, B, N).					

Hanging pedestal 	<i>1 box drawer and 1 file drawer with suspension bar. Pencil tray. Lock. Must be installed under a work surface. 1 tone only.</i>				
	15 x 17½ x 19¼	388 x 448 x 489	7N__-F		926
Specify the handle code (D, K). Specify the accent color (A, B, N).					

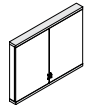
	W x D x H (in)	W x D x H (mm)	Code	Price (\$)
Round tops				
<i>Conference tables.</i>				
	36 x 36 x 1½	900 x 900 x 38	7_NN-R36	549
	42 x 42 x 1½	1050 x 1050 x 38	7_NN-R42	731
	48 x 48 x 1½	1200 x 1200 x 38	7_NN-R48	798
Specify the edge (N, 1, 2).				
Rectangular tops				
<i>Conference tables.</i>				
	72 x 36 x 1½	1800 x 900 x 38	7_NN-REC72	918
	96 x 48 x 1½	2400 x 1200 x 38	7_NN-REC96	1,298
Specify the edge (N, 1, 2).				
Boat-shape tops				
<i>Conference tables. 120" and 144" tops are in two pieces.</i>				
	96 x 48 x 1½	2400 x 1200 x 38	7_NN-B96	1,419
	120 x 48 x 1½	3000 x 1200 x 38	7_NN-B120	1,760
	144 x 48 x 1½	3600 x 1200 x 38	7_NN-B144	1,854
Specify the edge (N, 1, 2).				
144" to 120" : Packaged in 2 boxes.				
Racetrack tops				
<i>Conference tables. 120" and 144" tops are in two pieces.</i>				
	72 x 36 x 1½	1800 x 900 x 38	7_NN-RT72	1,047
	96 x 48 x 1½	2400 x 1200 x 38	7_NN-RT96	1,419
	120 x 48 x 1½	3000 x 1200 x 38	7_NN-RT120	1,760
	144 x 48 x 1½	3600 x 1200 x 38	7_NN-RT144	1,854
Specify the edge (N, 1, 2).				
144" to 120" : Packaged in 2 boxes.				
Cross bases				
<i>1½" thermofused laminate.</i>				
	22 x 22 x 28	555 x 555 x 710	LGC-CR22	532
	27 x 27 x 28	680 x 680 x 710	LGC-CR27	590
	33 x 33 x 28	825 x 825 x 710	LGC-CR33	669
V-bases				
<i>1½" thermofused laminate.</i>				
	18 x 18 x 28	450 x 450 x 710	LGC-2V18	(pair) 849
Drum base				
	18 x 18 x 28	460 x 460 x 710	LGC-DB19	1,249





	W x D x H (in)	W x D x H (mm)	Code	Price (\$)
Leg				
<i>Metal. Specify the finish: GAN Anthracite Grey, BRA Brass (add \$306) or NIC Nickel (add \$306).</i>				
	6 x 6 x 28	150 x 150 x 710	LGC-TL	(each) 396
Printer table				
<i>1 height adjustable sliding shelf. Grommet on back.</i>				
	30 x 24 x 29½	750 x 600 x 748	7_NN-2430PS	1,114
Specify the edge (N, 1, 2).				
Coffee table				
	22 x 22 x 18½	550 x 550 x 463	7_NN-ST222218	629
Specify the edge (N, 1, 2).				
Magazine table				
	48 x 22 x 18½	1200 x 550 x 463	7_NN-ST224818	742
Specify the edge (N, 1, 2).				
Mobile serving carts				
<i>1 sliding shelf, 1 box drawer. Pencil tray. 1 door. 1 shelf.</i>				
	20 x 21 x 36½	500 x 520 x 913	7_--MS212036	1,499
Specify the edge (N, 1, 2). Specify the handle code (D, K). Specify the accent color (A, B, N).				
<i>1 sliding shelf, 2 box drawers. Pencil tray. 2 doors. 2 shelves.</i>				
	36 x 21 x 36½	900 x 520 x 913	7_--MS213636	2,224
Specify the edge (N, 1, 2). Specify the handle code (D, K). Specify the accent color (A, B, N).				
Marker board				
<i>Non-magnetic surface for use with dry-erase markers. Eraser tray along bottom of board. Inside face of doors covered in natural cork. Hooks for paper pad. 180° hinges.</i>				
	54 x 5 x 41	1368 x 130 x 1043	7_--VBX4054	2,281
Specify the edge (N, 1, 2). Specify the handle code (D, K). Specify the accent color (A, B, N).				
Lectern				
<i>1 fixed shelf. 1 grommet. 4 casters, 2 with brakes.</i>				
	24 x 18 x 44½	600 x 450 x 1125	7_NN-LC181844	1,335
Specify the edge (N, 1, 2).				



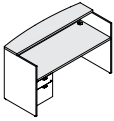

BASE OPTIONS / QUANTITY							
	Top Lengths	LGC-CR22	LGC-CR27	LGC-CR33	LGC-2V18	LGC-DB19	LGC-TL*
36" DEPTH	36"	1				1	4
	72"	2			1	2	4
42" DEPTH	42"		1				4
48" DEPTH	48"			1			4
	96"			2	1	2	4
	120"			3	1+1 CR33	3	6
	144"			3	1+1 CR33	3	6



* Not compatible with round tops.

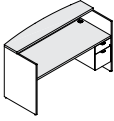

 = ASSEMBLY REQUIRED

 = QUICKSHIP PROGRAM

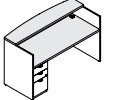
	W x D x H (in)	W x D x H (mm)	Code	Price (\$)
Right reception desks 	Desk with pedestal on left, 1 box drawer and 1 file drawer with suspension bar. Lock. Pencil tray. 2 grommets. Full-height modesty panel. Bow shaped transaction shelf.			
	72 x 30 x 42½	1800 x 750 x 1075	7___-GF3072S 	2,371
Specify the edge (N, 1, 2). Specify the handle code (D, K). Specify the accent color (A, B, N).				
	Right returns with pedestal on right, 1 box drawer and 1 file drawer with suspension bar. Lock. Pencil tray. 1 grommet. Full-height modesty panel.			
	48 x 24 x 41	1200 x 600 x 1037	7___-GR2448F	1,585
	42 x 24 x 41	1050 x 600 x 1037	7___-GR2442F 	1,557
Specify the edge (N, 1, 2). Specify the handle code (D, K). Specify the accent color (A, B, N).				

Left reception desks 	Desk with pedestal on right, 1 box drawer and 1 file drawer with suspension bar. Lock. Pencil tray. 2 grommets. Full-height modesty panel. Bow shaped transaction shelf.			
	72 x 30 x 42½	1800 x 750 x 1075	7___-GS3072F 	2,371
Specify the edge (N, 1, 2). Specify the handle code (D, K). Specify the accent color (A, B, N).				
	Left returns with pedestal on left, 1 box drawer and 1 file drawer with suspension bar. Lock. Pencil tray. 1 grommet. Full-height modesty panel.			
	48 x 24 x 41	1200 x 600 x 1037	7___-GF2448R	1,585
	42 x 24 x 41	1050 x 600 x 1037	7___-GF2442R 	1,557
Specify the edge (N, 1, 2). Specify the handle code (D, K). Specify the accent color (A, B, N).				

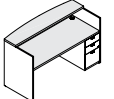
Right reception desks – low profile 	Desk with pedestal on left, 2 box drawers and 1 file drawer with suspension bar. Lock. Pencil tray. 2 grommets. Full-height modesty panel. Bow shaped transaction shelf.			
	72 x 30 x 42½	1800 x 750 x 1075	7___-GUF3072S	2,577
Specify the edge (N, 1, 2). Specify the handle code (D, K). Specify the accent color (A, B, N).				
	Right returns with pedestal on right, 2 box drawers and 1 file drawer with suspension bar. Lock. Pencil tray. 1 grommet. Full-height modesty panel.			
	48 x 24 x 41	1200 x 600 x 1037	7___-GR2448UF	1,786
	42 x 24 x 41	1050 x 600 x 1037	7___-GR2442UF	1,760
Specify the edge (N, 1, 2). Specify the handle code (D, K). Specify the accent color (A, B, N).				

Left reception desks – low profile 	Desk with pedestal on right, 2 box drawers and 1 file drawer with suspension bar. Lock. Pencil tray. 2 grommets. Full-height modesty panel. Bow shaped transaction shelf.			
	72 x 30 x 42½	1800 x 750 x 1075	7___-GS3072UF	2,577
Specify the edge (N, 1, 2). Specify the handle code (D, K). Specify the accent color (A, B, N).				
	Left returns with pedestal on left, 2 box drawers and 1 file drawer with suspension bar. Lock. Pencil tray. 1 grommet. Full-height modesty panel.			
	48 x 24 x 41	1200 x 600 x 1037	7___-GUF2448R	1,786
	42 x 24 x 41	1050 x 600 x 1037	7___-GUF2442R	1,760
Specify the edge (N, 1, 2). Specify the handle code (D, K). Specify the accent color (A, B, N).				

	W x D x H (in)	W x D x H (mm)	Code	Price (\$)
Additional legs 	1 full width leg. For AT, DT and CM tables.			
	30 x 1 x 27½	748 x 25 x 698	7NNN-L30	217
	24 x 1 x 27½	598 x 25 x 698	7NNN-L24	203
	20 x 1 x 27½	498 x 25 x 698	7NNN-L20	185

Additional legs 	1 recessed leg. For AT, DT and CM tables.			
	13 x 1 x 27½	340 x 25 x 698	7NNN-L12	168