



LacasseOfficeFurniture.com 201-254-0145

Groupe Lacasse Half Price Sale On Now

Take Half Off the List Prices in this PDF

Call 201-254-0145 Now

Free Layout & Design Service

C.I.T.E. Height Adjustable Tables



TABLE OF CONTENTS

SPECIFICATIONS

ELECTRIC HEIGHT ADJUSTABLE TABLES	3
WIRE MANAGEMENT MODULES	4
SCREENS	4
ELECTRIFICATION	4
SPECIFICATION OF OPTIONS AND FINISHES	5

C.I.T.É. ADDENDUM PRICE LIST

FREESTANDING HEIGHT ADJUSTABLE TABLES	5
WIRE MANAGEMENT MODULES	6
SCREENS	7
ELECTRIFICATION	7





SPECIFICATIONS

ELECTRIC HEIGHT ADJUSTABLE TABLES: ADDENDUM - C.I.T.É. - OFFICE FURNITURE SYSTEM

Electric height adjustable tables are very easy to use. They encourage active work (sitting/standing) and can be adjusted for users with different heights sharing the same workstation. Various base styles are offered.

Electric height adjustment

- Control keypad is installed beneath the work surface.
- Operating speed: 1¼" (32 mm) height adjustment per second.
- Sound level: 48 dB.
- Lift capacity of 2 columns: 264 lbs (120 kg).
- Recommended functional load capacity: 125 lbs (56 kg).
- Failure to respect the loads can cause the table/desk to malfunction.
- 120" L (3048 mm) cable with plug for wall outlet.
- Meet CSA and UL standards.



Digital control keypad with memory

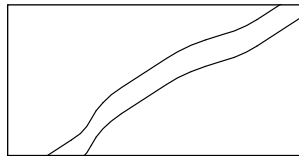

Smile-shaped middle cutout

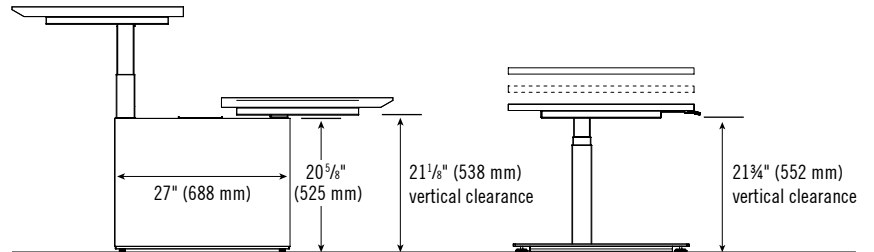

Integrated base

C-base

Different base styles

	Integrated base (metal/laminate)	Freestanding C-base (metal)
TOP 1" (25 mm)		
Lowest position	23 3/8" (594 mm)	24" (607 mm)
Highest position	49" (1244 mm)	49 1/2" (1257 mm)
TOP 1 1/2" (38 mm)		
Lowest position	24" (606 mm)	24 1/2" (620 mm)
Highest position	49 1/2" (1256 mm)	50" (1270 mm)

Electric height adjustable tables - integrated base

- When specified, the knife edge (K) is located on the user side only.
- Levelers with height adjustment of 1 1/2" (38 mm).
- The grommet option on the side of the bases allows cabling to pass through horizontally between 2 double-sided tables. A flexible horizontal fabric DW21 grommet is recommended.

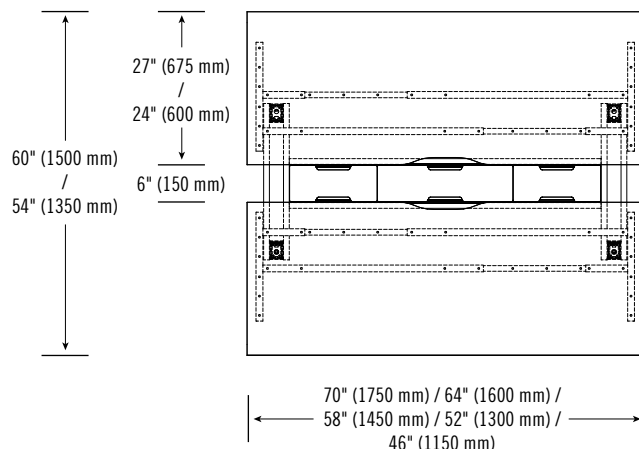

Electric height adjustable tables - freestanding base

- When specified, the knife edge (K) is located on the side of the users only.
- Levelers with height adjustment of 3/4" (20 mm).
- C-base: rectangular column of 2 1/2" W x 3" D (62 mm x 80 mm). Foot of 3/4" W x 22" D (80 mm x 559 mm).

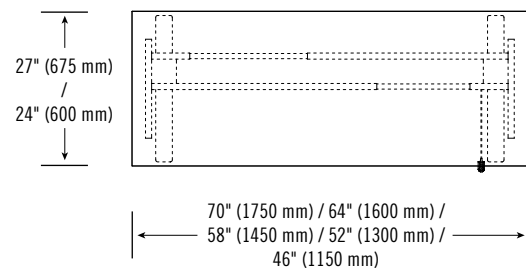

WIRE MANAGEMENT MODULES

Wire management modules and end panel

Wire management modules enable the creation of flexible and reconfigurable workstations when they are combined with electric height adjustable tables. End panels ensure the stability of single-sided and double-sided layouts.

- 22" high (561 mm), corresponding to the height of tables with double-sided surfaces and integrated bases. Offers a light and more effective layout.
- 29³/₈" high (745 mm), compatible with a fixed C.I.T.É. table with 1" thick (25 mm) surfaces.
- 29⁷/₈" high (757 mm), compatible with a fixed C.I.T.É. table with 1¹/₂" thick (38 mm) surfaces.
- A maximum length of 24' (7.2 m) for double-sided layouts and 16' (4.8 m) for single-sided layouts is recommended, regardless of the number of sections.
- Levelers with height adjustment of 1¹/₂" (38 mm).

When the components are assembled, the overall dimensions are planned according to a space required between 2 adjacent surfaces for wire management, which prevents fingers from getting pinched and allows the installation of surface privacy screens.

Double-sided layout

- Double-sided end panel bases, widths of 60" (1500 mm) or 66" (1650 mm).

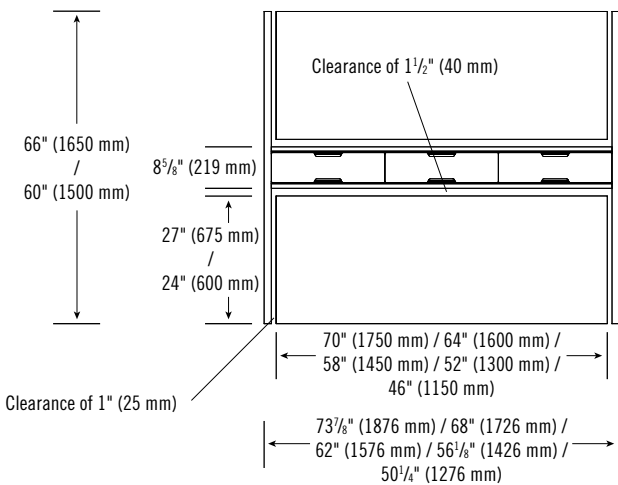

Single-sided layout

- Single-sided end panel bases, widths of 33⁷/₈" (860 mm) or 36³/₄" (935 mm).

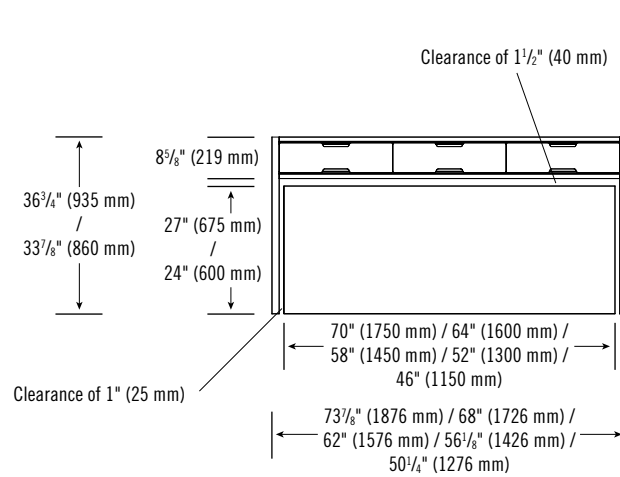

Layout using the combination of a fixed C.I.T.É. furniture system and a freestanding wire management module.

Example of an extension to a C.I.T.É. station containing fixed existing sections:

- 1 center panel base for double-sided surfaces CNNNS-LCAD6028.
- 1 wire management module CNNNS-LBAT7229.
- 1 end panel base CNN_S-LEAD6029.
- 2 electric height adjustable tables C1NN_-RCA2770G.

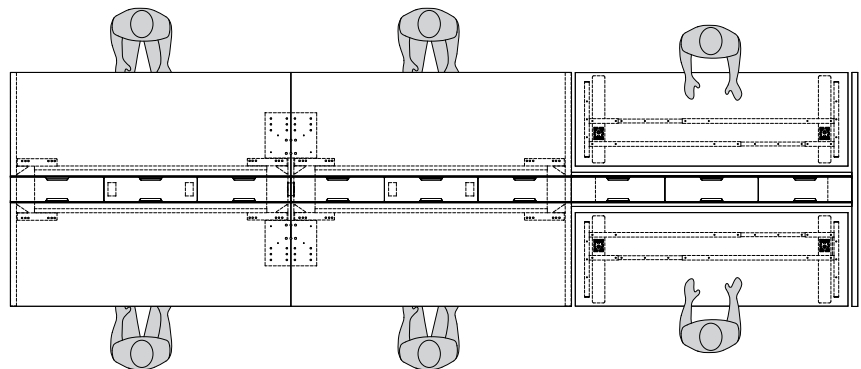

SCREENS

Screens help divide space depending on the level of privacy required while adding a warm touch to a workstation. They can be installed at the back or on the side of an electric height adjustable table surface.

- Panel composite of wood fibers, cardboard and recycled PVC covered in fabric.
- Fabric choice: see the current Lacasse upholstery guide. Vinyl and leather cannot be specified for screens. Available in 1 tone only.
- The fabric screens can be used as tackboards.
- Acrylic screens have a thickness of 1/4" (6 mm).
- The screens installed are 17³/₄" high (450 mm) on a 1" (25 mm) surface and 17¹/₄" high (437 mm) on a 1¹/₂" (38 mm) surface.

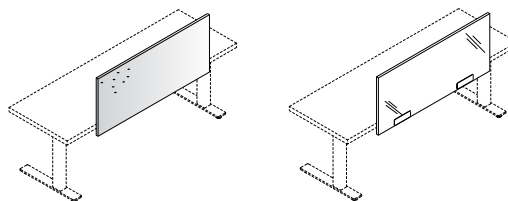

ELECTRIFICATION

Refer to the C.I.T.É. price book.

ELECTRIC HEIGHT ADJUSTABLE TABLES

C.I.T.É. ADDENDUM



SPECIFICATION OF OPTIONS AND FINISHES

EDGEBANDING

Automatically applied to the top and the sides.

N Edge



1" and 1½"
(25 mm and 38 mm)

N edging matches the finish specified for the surface.

K Knife Edge

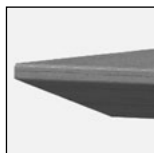

1½" (38 mm)

K knife-edge available (in coordinated colors) ONLY when a wood grain or Snow (SNO) finish is specified for the surface.

CODIFICATION

		Options					
Series	Thickness	Edgework	Options	Accent	Dash	Product	Options
C	1 Thermofused laminate 1" (25 mm)	N Smooth edge	N Base without grommet 1 Grommet on the base 2 Grommets on the base	S Silver W White	-		D Smile-shaped cutout on the surface
	2 High-pressure laminate 1" (25 mm)	K Knife-edge					
	5 Thermofused laminate 1½" (38 mm)						
	6 High-pressure laminate 1½" (38 mm)						

METAL BASES:

S - Silver or **W** - White



Integrated base



C-base

SCREENS / LATERAL SCREENS:

Acrylic



T - Translucent

Fabric



Several fabrics available. Refer to the current Lacasse upholstery selection guide.

FREESTANDING HEIGHT ADJUSTABLE TABLES

Electric height adjustable table with double-sided surfaces and channel

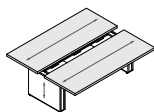

Smooth edge (N)

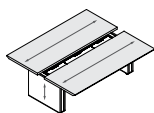

Knife-edge (K)

Smile-shaped cutout option on the surface, add D at the end of the code and \$130.

Double-sided surfaces with metal and laminate integrated bases as well as a channel for wire management. Translucent acrylic covers. 2 LGC-COM included. Compatible with privacy screens.

1" (25 mm) thick top. Lowest position is 23⅞" (594 mm) and highest position is 49" (1244 mm).

W x D x H (in)	W x D x H (mm)	Code	All Laminate (\$)	HPL Surfaces (\$)
70 x 60 x 23⅞-49	1750 x 1500 x 594-1244	C_N__-RCDAT6070SG	6,889	7,290
64 x 60 x 23⅞-49	1600 x 1500 x 594-1244	C_N__-RCDAT6064SG	6,947	7,203
58 x 60 x 23⅞-49	1450 x 1500 x 594-1244	C_N__-RCDAT6058SG	6,880	7,118
52 x 60 x 23⅞-49	1300 x 1500 x 594-1244	C_N__-RCDAT6052SG	6,817	7,024
46 x 60 x 23⅞-49	1150 x 1500 x 594-1244	C_N__-RCDAT6046SG	6,753	6,940
70 x 54 x 23⅞-49	1750 x 1350 x 594-1244	C_N__-RCDAT5470SG	6,982	7,234
64 x 54 x 23⅞-49	1600 x 1350 x 594-1244	C_N__-RCDAT5464SG	6,919	7,147
58 x 54 x 23⅞-49	1450 x 1350 x 594-1244	C_N__-RCDAT5458SG	6,860	7,068
52 x 54 x 23⅞-49	1300 x 1350 x 594-1244	C_N__-RCDAT5452SG	6,794	6,982
46 x 54 x 23⅞-49	1150 x 1350 x 594-1244	C_N__-RCDAT5446SG	6,739	6,904

Specify the surface type (1, 2). Specify if grommet in the base (N, 1, 2). Specify accent color (S, W).

1½" (38 mm) thick top. Lowest position is 24" (606 mm) and highest position is 49½" (1256 mm).

W x D x H (in)	W x D x H (mm)	Code	All Laminate (\$)	HPL Surfaces (\$)
70 x 60 x 24-49½	1750 x 1500 x 606-1256	C_N__-RCDAT6070SG	7,140	7,428
64 x 60 x 24-49½	1600 x 1500 x 606-1256	C_N__-RCDAT6064SG	7,068	7,326
58 x 60 x 24-49½	1450 x 1500 x 606-1256	C_N__-RCDAT6058SG	6,987	7,225
52 x 60 x 24-49½	1300 x 1500 x 606-1256	C_N__-RCDAT6052SG	6,919	7,125
46 x 60 x 24-49½	1150 x 1500 x 606-1256	C_N__-RCDAT6046SG	6,839	7,024
70 x 54 x 24-49½	1750 x 1350 x 606-1256	C_N__-RCDAT5470SG	7,096	7,348
64 x 54 x 24-49½	1600 x 1350 x 606-1256	C_N__-RCDAT5464SG	7,024	7,254
58 x 54 x 24-49½	1450 x 1350 x 606-1256	C_N__-RCDAT5458SG	6,952	7,161
52 x 54 x 24-49½	1300 x 1350 x 606-1256	C_N__-RCDAT5452SG	6,880	7,068
46 x 54 x 24-49½	1150 x 1350 x 606-1256	C_N__-RCDAT5446SG	6,811	6,975

Specify the surface type (5, 6). Specify if grommet in the base (N, 1, 2). Specify accent color (S, W).

W x D x H (in)	W x D x H (mm)	Code	All Laminate (\$)	HPL Surfaces (\$)
----------------	----------------	------	-------------------	-------------------

Electric height adjustable table with double-sided surfaces and channel (cont'd)

1½" (38 mm) thick top with knife edge. Lowest position is 24" (606 mm) and highest position is 49½" (1256 mm).				
70 x 60 x 24-49½	1750 x 1500 x 606-1256	C_K__-RCDAT6070SG	7,625	7,914
64 x 60 x 24-49½	1600 x 1500 x 606-1256	C_K__-RCDAT6064SG	7,555	7,812
58 x 60 x 24-49½	1450 x 1500 x 606-1256	C_K__-RCDAT6058SG	7,478	7,713
52 x 60 x 24-49½	1300 x 1500 x 606-1256	C_K__-RCDAT6052SG	7,405	7,612
46 x 60 x 24-49½	1150 x 1500 x 606-1256	C_K__-RCDAT6046SG	7,326	7,511
70 x 54 x 24-49½	1750 x 1350 x 606-1256	C_K__-RCDAT5470SG	7,584	7,833
64 x 54 x 24-49½	1600 x 1350 x 606-1256	C_K__-RCDAT5464SG	7,511	7,755
58 x 54 x 24-49½	1450 x 1350 x 606-1256	C_K__-RCDAT5458SG	7,440	7,676
52 x 54 x 24-49½	1300 x 1350 x 606-1256	C_K__-RCDAT5452SG	7,368	7,598
46 x 54 x 24-49½	1150 x 1350 x 606-1256	C_K__-RCDAT5446SG	7,298	7,511

Specify the surface type (5, 6). Specify if grommet in the base (N, 1, 2). Specify accent color (S, W).

Electric height adjustable rectangular tables, metal C-base

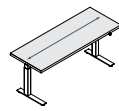

Smooth edge (N)

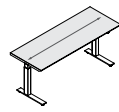

Knife-edge (K)

Smile-shaped cutout option on the surface, add D at the end of the code and \$130.

Metal C-base. 10' (3040 mm) cable with cord. Compatible with privacy screens. 1 tone only.

1" (25 mm) thick top. Lowest position is 24" (607 mm) and highest position is 49½" (1257 mm).

70 x 27 x 24-49½	1750 x 675 x 607-1257	C_NN_-RCA2770G	2,585	2,773
64 x 27 x 24-49½	1600 x 675 x 607-1257	C_NN_-RCA2764G	2,571	2,742
58 x 27 x 24-49½	1450 x 675 x 607-1257	C_NN_-RCA2758G	2,557	2,721
52 x 27 x 24-49½	1300 x 675 x 607-1257	C_NN_-RCA2752G	2,548	2,693
46 x 27 x 24-49½	1150 x 675 x 607-1257	C_NN_-RCA2746G	2,536	2,671
70 x 24 x 24-49½	1750 x 600 x 607-1257	C_NN_-RCA2470G	2,548	2,715
64 x 24 x 24-49½	1600 x 600 x 607-1257	C_NN_-RCA2464G	2,536	2,693
58 x 24 x 24-49½	1450 x 600 x 607-1257	C_NN_-RCA2458G	2,529	2,671
52 x 24 x 24-49½	1300 x 600 x 607-1257	C_NN_-RCA2452G	2,514	2,650
46 x 24 x 24-49½	1150 x 600 x 607-1257	C_NN_-RCA2446G	2,506	2,628

Specify the surface type (1, 2). Specify accent color (S, W).

2-TONE LAMINATE APPLICATION: SHADED AREA CORRESPONDS TO THE FIRST CODE TO BE SPECIFIED. SECOND LAMINATE CODE WILL BE APPLIED TO THE REST OF THE PRODUCT.

ASSEMBLY REQUIRED



W x D x H (in)	W x D x H (mm)	Code	All Laminate (\$)	HPL Surfaces (\$)
Electric height adjustable rectangular tables, metal C-base (cont'd)				
<i>1½" (38 mm) thick top. Lowest position is 24½" (620 mm) and highest position is 50" (1270 mm).</i>				
70 x 27 x 24½-50	1750 x 675 x 620-1270	C_NN_-RCA2770G	2,666	2,851
64 x 27 x 24½-50	1600 x 675 x 620-1270	C_NN_-RCA2764G	2,643	2,823
58 x 27 x 24½-50	1450 x 675 x 620-1270	C_NN_-RCA2758G	2,628	2,785
52 x 27 x 24½-50	1300 x 675 x 620-1270	C_NN_-RCA2752G	2,607	2,756
46 x 27 x 24½-50	1150 x 675 x 620-1270	C_NN_-RCA2746G	2,593	2,727
70 x 24 x 24½-50	1750 x 600 x 620-1270	C_NN_-RCA2470G	2,621	2,785
64 x 24 x 24½-50	1600 x 600 x 620-1270	C_NN_-RCA2464G	2,598	2,756
58 x 24 x 24½-50	1450 x 600 x 620-1270	C_NN_-RCA2458G	2,585	2,735
52 x 24 x 24½-50	1300 x 600 x 620-1270	C_NN_-RCA2452G	2,571	2,706
46 x 24 x 24½-50	1150 x 600 x 620-1270	C_NN_-RCA2446G	2,548	2,678

Specify the surface type (5, 6). Specify accent color (S, W).

1½" (38 mm) thick top with knife edge. Lowest position is 24½" (620 mm) and highest position is 50" (1270 mm).

70 x 27 x 24½-50	1750 x 675 x 620-1270	C_KN_-RCA2770G	2,929	3,116
64 x 27 x 24½-50	1600 x 675 x 620-1270	C_KN_-RCA2764G	2,908	3,087
58 x 27 x 24½-50	1450 x 675 x 620-1270	C_KN_-RCA2758G	2,885	3,051
52 x 27 x 24½-50	1300 x 675 x 620-1270	C_KN_-RCA2752G	2,863	3,015
46 x 27 x 24½-50	1150 x 675 x 620-1270	C_KN_-RCA2746G	2,844	2,987
70 x 24 x 24½-50	1750 x 600 x 620-1270	C_KN_-RCA2470G	2,879	3,051
64 x 24 x 24½-50	1600 x 600 x 620-1270	C_KN_-RCA2464G	2,863	3,021
58 x 24 x 24½-50	1450 x 600 x 620-1270	C_KN_-RCA2458G	2,844	2,994
52 x 24 x 24½-50	1300 x 600 x 620-1270	C_KN_-RCA2452G	2,823	2,963
46 x 24 x 24½-50	1150 x 600 x 620-1270	C_KN_-RCA2446G	2,808	2,936

Specify the surface type (5, 6). Specify accent color (S, W).

Double-sided end panel bases for wire management module - 29" H



Full 1½" (38 mm) thick end panel. To be used with a laminate wire management module. 1 tone only.

29¾" high (745 mm) bases:

66 x 1½ x 29¾	1650 x 38 x 745	CNN_S-LEAD6629	386
60 x 1½ x 29¾	1500 x 38 x 745	CNN_S-LEAD6029	366

Specify if grommet in the base (N, 1).

29" high (757 mm) bases:

66 x 1½ x 29"	1650 x 38 x 757	CNN_S-LEAD6630	392
60 x 1½ x 29"	1500 x 38 x 757	CNN_S-LEAD6030	373

Specify if grommet in the base (N, 1).

Double-sided end panel bases for wire management module - 22" H



Full 1½" (38 mm) thick end panel. To be used with a laminate wire management module. 1 tone only.

66 x 1½ x 22	1650 x 38 x 561	CNN_S-LEAD6622	337
60 x 1½ x 22	1500 x 38 x 561	CNN_S-LEAD6022	323

Specify if grommet in the base (N, 1).

Single-sided end panel bases for wire management module - 29" H



Left (L)



Right (R)

Full 1½" (38 mm) thick end panel. To be used with a laminate wire management module. 1 tone only.

29¾"-tall (745 mm) bases:

36¾ x 1½ x 29¾	935 x 38 x 745	CNN_S-LEAS3629_	287
33⅞ x 1½ x 29¾	860 x 38 x 745	CNN_S-LEAS3329_	279

Specify if grommet in the base (N, 1). Specify left (L) or right (R).

29" tall (757 mm) bases:

36¾ x 1½ x 29"	935 x 38 x 757	CNN_S-LEAS3630_	293
33⅞ x 1½ x 29"	860 x 38 x 757	CNN_S-LEAS3330_	279

Specify if grommet in the base (N, 1). Specify left (L) or right (R).

Single-sided end panel bases for wire management module - 22" H



Left (L)



Right (R)

Full 1½" (38 mm) thick end panel. To be used with a laminate wire management module. 1 tone only.

36¾ x 1½ x 22	935 x 38 x 561	CNN_S-LEAS3622_	257
33⅞ x 1½ x 22	860 x 38 x 561	CNN_S-LEAS3322_	251

Specify if grommet in the base (N, 1). Specify left (L) or right (R).

Center panel base for double-sided surfaces

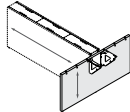

1½" (38 mm) full center panel base. Goes at the junction of fixed C.I.T.É. surfaces and a 29" H electrification and communication module. Hardware included. 1 tone only.

60 x 1½ x 28	1500 x 38 x 719	CNNNS-LCAD6028	638
--------------	-----------------	-----------------------	------------

WIRE MANAGEMENT MODULES

Wire management modules - 29" H

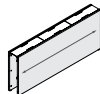

Laminate module. Wire channels with anodized aluminum edges and translucent acrylic covers. 2 LGC-COM included. Must be used with end panel bases. 1 tone only.

29¾" high (745 mm) modules for 1" thick (25 mm) top:

72 x 7⅞ x 29¾	1800 x 219 x 745	CNNNS-LBAT7229	1,247
66 x 7⅞ x 29¾	1650 x 219 x 745	CNNNS-LBAT6629	1,175
60 x 7⅞ x 29¾	1500 x 219 x 745	CNNNS-LBAT6029	1,102
54 x 7⅞ x 29¾	1350 x 219 x 745	CNNNS-LBAT5429	1,033
48 x 7⅞ x 29¾	1200 x 219 x 745	CNNNS-LBAT4829	960

29" high (757 mm) modules for 1½" thick (38 mm) top:

72 x 7⅞ x 29"	1800 x 219 x 757	CNNNS-LBAT7230	1,268
66 x 7⅞ x 29"	1650 x 219 x 757	CNNNS-LBAT6630	1,196
60 x 7⅞ x 29"	1500 x 219 x 757	CNNNS-LBAT6030	1,117
54 x 7⅞ x 29"	1350 x 219 x 757	CNNNS-LBAT5430	1,045
48 x 7⅞ x 29"	1200 x 219 x 757	CNNNS-LBAT4830	967

Wire management modules - 22" H

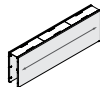

Laminate module. Wire channels with anodized aluminum edges and translucent acrylic covers. 2 LGC-COM included. Must be used with end panel bases. 1 tone only.

72 x 7⅞ x 22	1800 x 219 x 561	CNNNS-LBAT7222	1,160
66 x 7⅞ x 22	1650 x 219 x 561	CNNNS-LBAT6622	1,096
60 x 7⅞ x 22	1500 x 219 x 561	CNNNS-LBAT6022	1,033
54 x 7⅞ x 22	1350 x 219 x 561	CNNNS-LBAT5422	972
48 x 7⅞ x 22	1200 x 219 x 561	CNNNS-LBAT4822	910

2-TONE LAMINATE APPLICATION: SHADED AREA CORRESPONDS TO THE FIRST CODE TO BE SPECIFIED. SECOND LAMINATE CODE WILL BE APPLIED TO THE REST OF THE PRODUCT.

= ASSEMBLY REQUIRED

W x D x H (in) W x D x H (mm) Code Price (\$)

SCREENS

Refer to the current Lacasse upholstery selection guide.

Privacy screens for surface

Tackable fabric screens. Mount to electric height adjustable tables.

Privacy screens		Gr1	Gr2	Gr3	Gr4	Gr5	Gr6	Gr8
70 x 3/4 x 18	1750 x 19 x 513	CNNNS-SCAF7018	656	694	732	754	825	908 1,023
64 x 3/4 x 18	1600 x 19 x 513	CNNNS-SCAF6418	638	674	711	729	796	870 978
58 x 3/4 x 18	1450 x 19 x 513	CNNNS-SCAF5818	620	654	685	702	763	831 926
52 x 3/4 x 18	1300 x 19 x 513	CNNNS-SCAF5218	544	576	604	618	670	732 822
46 x 3/4 x 18	1150 x 19 x 513	CNNNS-SCAF4618	469	493	519	532	582	635 714
Lateral privacy screens								
27 x 3/4 x 18	675 x 19 x 513	CNNNS-SCAF2718	443	459	475	482	511	543 589
24 x 3/4 x 18	600 x 19 x 513	CNNNS-SCAF2418	434	448	461	469	493	524 565

Specify the fabric code at the end of the product code.

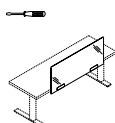
Privacy screens for surface

Acrylic screens. Mount to electric height adjustable tables.

Privacy screens			
70 x 1/4 x 18	1750 x 6 x 513	CNNN_-SCAT7018	603
64 x 1/4 x 18	1600 x 6 x 513	CNNN_-SCAT6418	587
58 x 1/4 x 18	1450 x 6 x 513	CNNN_-SCAT5818	571
52 x 1/4 x 18	1300 x 6 x 513	CNNN_-SCAT5218	558
46 x 1/4 x 18	1150 x 6 x 513	CNNN_-SCAT4618	524
Lateral privacy screens			
27 x 1/4 x 18	675 x 6 x 513	CNNN_-SCAT2718	480
24 x 1/4 x 18	600 x 6 x 513	CNNN_-SCAT2418	437

Specify accent color (S, W).

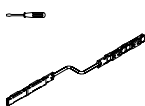
ELECTRIFICATION
Electric kit for channel and modules

4 duplex receptacles with cables. Black. Compatible with 72" (1800 mm) to 48" (1200 mm) wire management modules and 70" (1750 mm) to 60" (1500 mm) long integrated bases tables.

LGC-4TRAC472C_ **501**

Specify circuit number at the end of the code (1, 2).

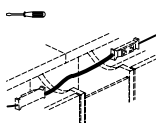
Pass cable

Connects 2 adjacent channels.

LGC-PASS36 **193**

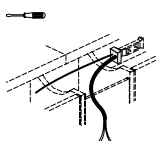
Electrical feed from floor

72" (1828 mm) long cable. Must be installed by an electrician.

LGC-FFEED72 **316**

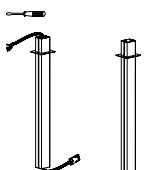
Electrical ceiling feed

Post and cable: 120" (3000 mm) tall aluminum post. Silver. 132" (3353 mm) long cable. Screws and supports included. Must be installed by an electrician.

CNNNS-CFEED120 **774**

Post: 120" (3000 mm) tall aluminum post. Silver.

CNNNS-POLE120 **605**

Flexible horizontal fabric grommet



Allows cabling to be managed horizontally. 2" (50 mm) diameter. With zipper. All Lacasse standard fabrics are applicable.

	Gr1	Gr2	Gr3	Gr4	Gr5	Gr6	Gr8
2 x 2 x 21	50 x 50 x 533	DVW21	84	85	95	97	106 115 130

Specify the fabric code at the end of the product code.

= ASSEMBLY REQUIRED

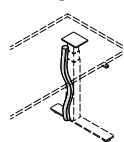
W x D x H (in) W x D x H (mm) Code Price (\$)

Flexible vertical fabric grommet

Allows cabling to be managed vertically. 2" diameter. With zipper. All Lacasse standard fabrics are applicable.

	Gr1	Gr2	Gr3	Gr4	Gr5	Gr6	Gr8
2 x 2 x 39	50 x 50 x 991	DVW34	95	96	104	106	115 129 144

Specify the fabric code at the end of the product code.

Wire management clips

Allow cables to be clipped under the work surface. Grey. Package of 5 clips.

5 1/2 x 1 1/2 x 1 140 x 40 x 25 **LGC-WMC05** **124**